

# Operation Manual

DVD AV RECEIVER

# AVH-P4000DVD

**SUPER**  **TUNER III D**

---

*English*

## Thank you for buying this Pioneer product.

Please read through these operating instructions so you will know how to operate your model properly. *After you have finished reading the instructions, keep this manual in a safe place for future reference.*



### Be sure to read this

- Playable discs **9**
- DVD video disc region numbers **9**
- When an operation is prohibited **13**

### 01 Precautions

#### IMPORTANT SAFEGUARDS **6**

- To ensure safe driving **6**
  - Parking brake interlock **7**
  - When using a display connected to REAR MONITOR OUTPUT **7**
  - When using a rear view camera **7**
- To avoid battery exhaustion **7**

### 02 Before You Start

- Information to User **8**
- For Canadian model **8**
- About this unit **8**
  - Playable discs **9**
  - DVD video disc region numbers **9**
- About this manual **9**
- After sales service for Pioneer products **9**
- Visit our website **10**
- Features **10**
  - About WMA **11**
  - About MP3 **12**
  - About AAC **12**
  - About DivX **12**
  - About the SAT RADIO READY mark **12**
- To protect the LCD screen **12**
- For viewing LCD comfortably **13**
  - Changing the wide screen size **13**
  - Changing the picture adjustment **13**
- What the marks on DVDs indicate **13**
  - When an operation is prohibited **13**
- Resetting the microprocessor **13**
- Feature demo mode **14**

### 03 Operating this unit

- What's What **15**
  - Head unit **15**
  - Optional remote control **15**
- Basic Operations **16**
  - Power ON/OFF **16**
  - Selecting a source **16**
  - Adjusting the volume **17**
  - Touch panel key basic operation **17**
- Radio **18**
  - Basic Operations **18**
  - Storing and recalling broadcast frequencies **18**
  - Introduction of advanced operations **18**
  - Storing the strongest broadcast frequencies **19**
  - Tuning in strong signals **19**
- Built in DVD player **19**
  - Basic Operations **19**
  - Basic playback controls **20**
  - Switching the media file type **21**
  - Operating the DVD menu **21**
  - PBC playback **21**
  - Playing DivX® VOD content **22**
  - Skipping back or forward to another title **22**
  - CM skip/CM back **22**
  - Resume playback (Bookmark) **22**
  - Searching for the part you want to play **23**
  - Changing audio language during playback (Multi audio) **23**
  - Changing the subtitle language during playback (Multi subtitle) **23**
  - Changing the viewing angle during playback (Multi angle) **24**
  - Frame by frame playback **24**
  - Slow motion playback **24**

- Return to the specified scene **24**
- Automatic playback of DVDs **25**
- Text information **25**
- Selecting tracks from the track list **25**
- Selecting files from the file name list **25**
- Introduction of advanced operations **26**
- Repeating play **26**
- Playing tracks in random order **26**
- Scanning tracks or folders **26**
- Selecting audio output **27**
- Using compression **27**
- Playing songs on iPod **27**
  - Basic Operations **27**
  - Playing video **28**
  - Browsing for a song/video **28**
  - Displaying text information on iPod **28**
  - Repeating play **29**
  - Playing songs in a random order (shuffle) **29**
  - Playing all songs in a random order (shuffle all) **29**
  - Operating this unit's iPod function from your iPod **29**
  - Pausing a song **29**
  - Selecting songs from album list of currently playing artist **29**
  - Changing audiobook speed **30**
- Playing songs on USB portable audio player/  
USB memory **30**
  - Basic Operations **30**
  - Pausing compressed audio playback **31**
  - Introduction of advanced operations **31**
  - Displaying text information of an audio file **31**
  - Selecting files from the file name list **31**
- Audio Adjustments **32**
  - Introduction of audio adjustments **32**
  - Using balance adjustment **32**
  - Using the equalizer **32**
  - Adjusting loudness **33**
  - Using subwoofer output **33**
  - Boosting the bass **34**
  - Using the high pass filter **34**
  - Adjusting source levels **34**
- Setting up the DVD player **35**
  - Introduction of DVD setup adjustments **35**
  - Setting the subtitle language **35**
  - Setting the audio language **35**
  - Setting the menu language **36**
  - Switching the assist subtitle on or off **36**
  - Setting the angle icon display **36**
  - Setting the aspect ratio **36**
  - Setting the parental lock **36**
  - Setting the DivX subtitle file **37**
  - Displaying your DivX® VOD registration code **37**
  - Setting for digital output **38**
- Initial Settings **38**
  - Adjusting initial settings **38**
  - Switching the auxiliary setting **38**
  - Setting the rear output and subwoofer controller **39**
  - Changing languages for CAUTION **39**
  - Switching the sound muting/attenuation **39**
  - Entering PIN code for Bluetooth wireless connection **40**
  - Correcting distorted sound **40**
  - Resetting the audio functions **40**
- Other Functions **41**

Introduction of system adjustments	41
Changing the wide screen mode	41
Changing the picture adjustment	41
Selecting the background display	42
Setting the AV input	42
Setting the clock	43
Setting for rear view camera (back up camera)	43
Switching the iPod charge setting	43
Selecting the OSD color	44
Selecting the illumination color	44
Adjusting the response positions of the touch panels (Touch Panel Calibration)	44
Using the AUX source	45
Using the external unit	46
Using the PGM button	46

## 04 Available accessories

XM tuner	48
Basic Operations	48
Storing and recalling broadcast stations	48
Switching the XM channel select mode	49
Selecting an XM channel directly	49
Using the MyMix function	49
Displaying the Radio ID	50
Switching the XM display	51
SIRIUS Satellite Radio tuner	51
Basic Operations	51
Storing and recalling broadcast stations	52
Selecting the SIRIUS channel select mode	52
Selecting a SIRIUS channel directly	53
Using the MyMix function	53
Using the Game Alert function	54

Displaying the Radio ID	55
Switching the SIRIUS display	55
Using Instant Replay function	55
Bluetooth Audio	56
Basic Operations	56
Pausing playback	57
Introduction of advanced operations	57
Connecting a Bluetooth audio player	57
Disconnecting a Bluetooth audio player	57
Displaying BD (Bluetooth Device) address	57
Bluetooth Telephone	58
Basic Operations	58
Setting up for hands free phoning	59
Making a phone call	59
Taking a phone call	59
Introduction of advanced operations	60
Connecting a cellular phone	60
Disconnecting a cellular phone	60
Registering a connected cellular phone	61
Deleting a registered phone	61
Connecting to a registered cellular phone	61
Using the phone book	61
Using the call history	63
Using preset numbers	63
Making a call by entering phone number	64
Clearing memory	64
Setting automatic answering	64
Setting automatic rejecting	64
Switching the ring tone	64
Echo canceling and noise reduction	65

- Displaying BD (Bluetooth Device) address **65**
- Multi CD Player **65**
  - Basic Operations **65**
  - Selecting a disc **66**
  - Pausing CD playback **66**
  - Introduction of advanced operations **66**
  - Using CD TEXT functions **66**
- DVD Player **67**
  - Basic Operations **67**
  - Selecting a disc **67**
  - Selecting a folder **67**
  - Pausing disc playback **67**
  - Introduction of advanced operations **68**
- TV tuner **69**
  - Basic Operations **69**
  - Storing and recalling broadcast stations **69**
  - Storing the strongest broadcast stations sequentially **69**
- Digital Signal Processor **70**
  - Introduction of DSP adjustments **70**
  - Using the sound field control **71**
  - Using the position selector **71**
  - Using balance adjustment **72**
  - Adjusting source levels **72**
  - Using the dynamic range control **72**
  - Using the down mix function **73**
  - Using the direct control **73**
  - Using the Dolby Pro Logic II **73**
  - Setting the speaker setting **74**
  - Adjusting the speaker output levels **75**
  - Selecting a cross over frequency **75**
  - Adjusting the speaker output levels using a test tone **75**
  - Using the time alignment **76**
  - Using the equalizer **77**
  - Using the auto equalizer **78**
  - Auto TA and EQ (auto time alignment and auto equalizing) **78**
- **Additional Information**
  - Troubleshooting **81**
  - Error messages **83**
  - Understanding auto TA and EQ error messages **85**
  - Handling guideline of discs and player **86**
    - DVD discs **86**
    - DVD R/DVD RW discs **86**
    - AVCHD recorded discs **86**
    - CD R/CD RW discs **86**
    - Dual Discs **87**
  - Compressed audio files on the disc **87**
    - Example of a hierarchy **87**
    - Compressed audio compatibility **88**
  - USB audio player/USB memory **88**
    - USB audio player/USB memory compatibility **88**
    - Handling guideline and supplemental information **88**
    - Compressed audio compatibility **89**
  - DivX video files **90**
    - DivX compatibility **90**
  - About handling the iPod **90**
    - About iPod settings **90**
  - Using the display correctly **90**
    - Handling the display **91**
    - Liquid crystal display (LCD) screen **91**
    - Keeping the display in good condition **91**
    - Small fluorescent tube **91**
  - Language code chart for DVD **92**
  - Terms **93**
  - Specifications **96**
- **Index** **98**

## IMPORTANT SAFEGUARDS

Please read all of these instructions regarding your display and retain them for future reference.

- 1 **Read this manual fully and carefully before operating your display.**
- 2 **Keep this manual handy as a reference for operating procedures and safety information.**
- 3 **Pay close attention to all warnings in this manual and follow the instructions carefully.**
- 4 **Do not allow other persons to use this system until they have read and understood the operating instructions.**
- 5 **Do not install the display where it may (i) obstruct the driver's vision, (ii) impair the performance of any of the vehicle's operating systems or safety features, including air bags, hazard lamp buttons or (iii) impair the driver's ability to safely operate the vehicle.**
- 6 **Do not operate this display if doing so in any way will divert your attention from the safe operation of your vehicle. Always observe safe driving rules and follow all existing traffic regulations. If you experience difficulty in operating the system or reading the display, park your vehicle in a safe location and make necessary adjustments.**
- 7 **Please remember to wear your seat belt at all times while operating your vehicle. If you are ever in an accident, your injuries can be considerably more severe if your seat belt is not properly buckled.**
- 8 **Never use headphones while driving.**
- 9 **To promote safety, certain functions are disabled unless the parking brake is on, and the vehicle is not in motion.**
- 10 **Never set the volume of your display so high that you cannot hear outside traffic and emergency vehicles.**

### WARNING

- **Do not attempt to install or service your display by yourself. Installation or servicing of the display by persons without training and experience in electronic equipment and automotive accessories may be dangerous and could expose you to the risk of electric shock or other hazards.** 

## To ensure safe driving

### WARNING

- **LIGHT GREEN LEAD AT POWER CONNECTOR IS DESIGNED TO DETECT PARKED STATUS AND MUST BE CONNECTED TO THE POWER SUPPLY SIDE OF THE PARKING BRAKE SWITCH. IMPROPER CONNECTION OR USE OF THIS LEAD MAY VIOLATE APPLICABLE LAW AND MAY RESULT IN SERIOUS INJURY OR DAMAGE.**
- To avoid the risk of damage and injury and the potential violation of applicable laws, this unit is not for use with a video screen that is visible to the driver.
- To avoid the risk of accident and the potential violation of applicable laws, the front DVD or TV (sold separately) feature should never be used while the vehicle is being driven. Also, rear displays should not be in a location where it is a visible distraction to the driver.
- In some countries or states the viewing of images on a display inside a vehicle even by persons other than the driver may be illegal. Where such regulations apply, they must be obeyed and this unit's DVD features should not be used.

When you attempt to watch a DVD, Video CD or TV while driving, the warning **Viewing of front seat video source while driving is strictly prohibited.** will appear on the front display.

## Precautions

To watch a DVD, Video CD or TV on the front display, park your vehicle in a safe place and apply the parking brake.

### Parking brake interlock

Certain functions (DVD/TV viewing and certain touch panel keys) offered by this unit could be dangerous and/or unlawful if used while driving. To prevent such functions from being used while the vehicle is in motion, there is an interlock system that senses when the parking brake is set. If you attempt to use the functions described above while driving, they will be come disabled until you stop the vehicle in a safe place, and (1) apply the parking brake, (2) release the parking brake, and then (3) apply the parking brake again. Please keep the brake pedal pushed down before releasing the parking brake.

### When using a display connected to REAR MONITOR OUTPUT

This unit's **REAR MONITOR OUTPUT** is for connection of a display to enable passengers in the rear seats to watch the DVD or TV.

#### **WARNING**

**NEVER** install the rear display in a location that enables the driver to watch the DVD or TV while driving.

### When using a rear view camera

With an optional rear view camera, you are able to use this unit as an aid to keep an eye on trailers, or backing into a tight parking spot.

#### **WARNING**

- **SCREEN IMAGE MAY APPEAR REVERSED.**
- **USE INPUT ONLY FOR REVERSE OR MIRROR IMAGE REAR VIEW CAMERA.**

### OTHER USE MAY RESULT IN INJURY OR DAMAGE.

#### **CAUTION**

- The rear view camera function is to be used as an aid to keep an eye on trailers, or while backing up. Do not use for entertainment purposes.
- Please note that the edges of the rear view camera images may differ slightly according to whether full screen images are displayed when backing up, and whether the images are used for checking the rear when the vehicle is moving forward. 

### To avoid battery exhaustion

Be sure to run the vehicle engine while using this unit. Using this unit without running the engine can result in battery drainage.

- When no power is supplied to this unit because of a replacement of the vehicle battery or for some similar reason, the microcomputer of this unit is returned to its initial condition. We recommend that you transcribe the audio adjustment data.

#### **WARNING**

Do not use with vehicles that do not feature an ACC position. 

## Information to User

Alteration or modifications carried out without appropriate authorization may invalidate the user's right to operate the equipment.



## For Canadian model

This Class B digital apparatus complies with Canadian ICES 003.



## About this unit

The tuner frequencies on this unit are all catered for use in North America. Use in other areas may result in poor reception.

### WARNING

Handling the cord on this product or cords associated with accessories sold with the product may expose you to chemicals listed on proposition 65 known to the State of California and other governmental entities to cause cancer and birth defects or other reproductive harm. **Wash hands after handling.**

This product contains mercury. Disposal of this material may be regulated due to environmental considerations. For disposal or recycling information, please contact your local authorities or the Electronics Industries Alliance: [www.eiae.org](http://www.eiae.org)

The backlighting lamp of LCD in this equipment contains mercury. Disposal of this material may be regulated due to environmental considerations according to Local, State or Federal Laws. For disposal or recycling information, please contact your local authorities or the Electronics Industries Alliance: [www.eiae.org](http://www.eiae.org)

**CAUTION:**  
**USE OF CONTROL OR ADJUSTMENT OR PERFORMANCE OF PROCEDURES OTHER THAN THOSE SPECIFIED HEREIN MAY RESULT IN HAZARDOUS RADIATION EXPOSURE.**

**CAUTION:**  
**THE USE OF OPTICAL INSTRUMENTS WITH THIS PRODUCT WILL INCREASE EYE HAZARD.**

### CAUTION

- Do not allow this unit to come into contact with liquids. Electrical shock could result. Also, damage to this unit, smoke, and over heating could result from contact with liquids.
- Keep this manual handy as a reference for operating procedures and precautions.
- Always keep the volume low enough so that you can hear sounds from outside the vehicle.
- Protect this unit from moisture.
- If the battery is disconnected or discharged, the preset memory will be erased and must be reprogrammed.

### Important (Serial number)

The serial number is located on the bottom of this unit. For your own security and convenience, be sure to record this number on the enclosed warranty card.



## Before You Start

### Playable discs

DVD, Video CD and CD discs that display the logos shown below can be played back on this player.

#### DVD video



#### Video CD



#### CD



#### Notes

- **DVD** is a trademark of DVD Format/Logo Licensing Corporation.
- This player can only play back discs bearing the marks shown above.

### DVD video disc region numbers

DVD video discs that have incompatible region numbers cannot be played on this player. The region number of the player can be found on the bottom of this unit.

The illustration below shows the regions and corresponding region numbers.



### About this manual

This unit features a number of sophisticated functions ensuring superior reception and operation. All the functions have been designed for the easiest possible use, but many are not self-explanatory. This operation manual will help you benefit fully from this unit's potential and to maximize your listening enjoyment. We recommend that you familiarize yourself with the functions and their operation by reading through the manual before you begin using this unit. It is especially important that you read and observe **WARNINGS** and **CAUTIONS** in this manual. □

### After-sales service for Pioneer products

Please contact the dealer or distributor from where you purchased this unit for after sales service (including warranty conditions) or any other information. In case the necessary information is not available, please contact the companies listed below:

Please do not ship your unit to the companies at the addresses listed below for repair without advance contact.

## Before You Start

### U.S.A.

Pioneer Electronics (USA) Inc.  
CUSTOMER SUPPORT DIVISION  
P.O. Box 1760  
Long Beach, CA 90801 1760  
800 421 1404

### CANADA

Pioneer Electronics of Canada, Inc.  
CUSTOMER SATISFACTION DEPARTMENT  
300 Allstate Parkway  
Markham, Ontario L3R 0P2  
1 877 283 5901  
905 479 4411

For warranty information please see the Limited Warranty sheet included with this unit. 

## Visit our website

Visit us at the following site:

<http://www.pioneerelectronics.com>

- 1 Register your product. We will keep the details of your purchase on file to help you refer to this information in the event of an insurance claim such as loss or theft.
- 2 Receive updates on the latest products and technologies.
- 3 Download owner's manuals, order product catalogues, research new products, and much more.
- 4 Your feedback is important in our continual effort to design and build the most advanced, consumer focused product in the industry.

### Serial number



## Features

### Touch panel key operation

It is possible to operate this unit by using touch panel key.

### DVD-R/RW compatibility

It is possible to play back DVD R/RW discs recorded with the video format and Video Recording format. (Refer to *DVD R/DVD RW discs* on page 86.)

### Video CDs featuring PBC compatibility

It is possible to play back Video CDs featuring PBC (playback control).

### WMA, MP3 and AAC compatibility

Refer to *Compressed audio compatibility* on page 88.

### DivX® video compatibility

Refer to *DivX compatibility* on page 90.

### Dolby Digital/DTS compatibility

When using this unit with a Pioneer multi channel processor, you can enjoy the atmosphere and excitement provided by DVD movie and music software featuring 5.1 channel recordings.

- Manufactured under license from Dolby Laboratories. "Dolby", "Pro Logic", and the double D symbol are trademarks of Dolby Laboratories.



## Before You Start

- Manufactured under license under U.S. Patent #: 5,451,942 & other U.S. and world wide patents issued & pending. DTS and DTS Digital Out are registered trademarks and the DTS logos and Symbol are trademarks of DTS, Inc. © 1996 2007 DTS, Inc. All Rights Reserved.



### Portable audio player compatibility

- Inquire at the manufacturer about your USB portable audio player/USB memory.

This unit corresponds to the following.

USB MSC (Mass Storage Class) compliant portable audio player and memory  
WMA, MP3, AAC and WAV file playback

For details about the compatibility, refer to *Compressed audio compatibility* on page 89.

### iPod® compatibility

This unit can control and listen to songs on an iPod.

- This unit supports only the following iPods. Supported iPod software versions are shown below. Older versions of iPod software may not be supported.
  - iPod third generation (software version 2.3.0)
  - iPod fourth generation (software version 3.1.1)
  - iPod photo (software version 1.2.1)
  - iPod fifth generation (software version 1.2.1)
  - iPod mini (software version 1.4.1)
  - iPod nano first generation (software version 1.3.1)
  - iPod nano second generation (software version 1.1.3)
  - iPod nano third generation (software version 1.0.2)
  - iPod classic (software version 1.0.2)
  - iPod touch (software version 1.1.1)

- Music files on iPod touch can be played back.

- When using an iPod, Interface Cable for iPod (e.g., CD I200) is required.
- Operations may vary depending on the software version of iPod.
- iPod is a trademark of Apple Inc., registered in the U.S. and other countries.



### Note

This product incorporates copyright protection technology that is protected by method claims of certain U.S. patents and other intellectual property rights owned by Macrovision Corporation and other rights owners. Use of this copyright protection technology must be authorized by Macrovision Corporation, and is intended for home and other limited viewing uses only unless otherwise authorized by Macrovision Corporation. Reverse engineering or disassembly is prohibited.

### About WMA



The Windows Media™ logo printed on the box indicates that this unit can play back WMA data.

- Windows Media and the Windows logo are trademarks or registered trademarks of Microsoft Corporation in the United States and/or other countries.
- This unit may not operate correctly depending on the application used to encode WMA files.

## Before You Start

### About MP3

Supply of this product only conveys a license for private, non commercial use and does not convey a license nor imply any right to use this product in any commercial (i.e. revenue generating) real time broadcasting (terrestrial, satellite, cable and/or any other media), broadcasting/streaming via internet, intranets and/or other networks or in other electronic content distribution systems, such as pay audio or audio on demand applications. An independent license for such use is required. For details, please visit <http://www.mp3licensing.com>.

### About AAC

This unit plays back AAC files encoded by iTunes®.

- iTunes is a trademark of Apple Inc., registered in the U.S. and other countries.

### About DivX



DivX is a compressed digital video format created by the DivX® video codec from DivX, Inc. This unit can play DivX video files recorded on CD R/RW/ROM and DVD R/RW/ROM discs. Keeping the same terminology as DVD video, individual DivX video files are called "Titles". When naming files/titles on a CD R/RW or a DVD R/RW disc prior to burning, keep in mind that by default they will be played in alphabetical order.

Official DivX® Certified product

Plays all versions of DivX® video (including DivX® 6) with standard playback of DivX® media files

- DivX, DivX Certified, and associated logos are trademarks of DivX, Inc. and are used under license.

### About the SAT RADIO READY mark



The SAT RADIO READY mark indicates that the Satellite Radio Tuner for Pioneer (i.e., XM tuner and Sirius satellite tuner which are sold separately) can be controlled by this unit. Please inquire to your dealer or nearest authorized Pioneer service station regarding the satellite radio tuner that can be connected to this unit. For satellite radio tuner operation, please refer to the satellite radio tuner owner's manual.

- The system will use direct satellite to receiver broadcasting technology to provide listeners in their cars and at home with crystal clear sound seamlessly from coast to coast. Satellite radio will create and package over 100 channels of digital quality music, news, sports, talk and children's programming.
- "SAT Radio", the SAT Radio logo and all related marks are trademarks of Sirius Satellite Radio inc., and XM Satellite Radio Inc. ■

### To protect the LCD screen

- Do not allow direct sunlight to fall on the display when this unit is not being used. Extended exposure to direct sunlight can result in LCD screen malfunction due to the resulting high temperatures.
- When using a cellular phone, keep the antenna of the cellular phone away from the display to prevent disruption of the video by the appearance of spots, colored stripes, etc.
- Never touch the screen with anything besides your finger when operating the touch panel function. The screen can scratch easily. ■

## Before You Start

### For viewing LCD comfortably

Due to its construction, the viewing angle of the LCD screen is limited. You can adjust it by changing either screen size or picture adjustment.

### Changing the wide screen size

By changing the screen size from 4:3 to 16:9, you can adjust the screen so that the screen can fit to the video image you are playing. For details concerning operation, refer to *Changing the wide screen mode* on page 41.





### Changing the picture adjustment

You can make the best adjustment to the picture display by changing **BRIGHTNESS**, **CONTRAST**, **COLOR** and **HUE**. You can also dim or enlighten the overall picture image using **DIMMER**.

For details concerning operation, refer to *Changing the picture adjustment* on page 41. 



### What the marks on DVDs indicate

The marks below may be found on DVD disc labels and packages. They indicate the type of images and audio recorded on the disc, and the functions you can use.

Mark	Meaning
	Indicates the number of audio systems.
	Indicates the number of subtitle languages.
	Indicates the number of viewing angles.
	Indicates the picture size (aspect ratio: screen width to height ratio) type.
	Indicates the number of the region where playback is possible.

### When an operation is prohibited

When you are watching a DVD and attempt to perform an operation, it may not be performed because of the programming on the disc. When this happens, the icon  appears on the screen.

- The icon  may not appear with certain discs. 

### Resetting the microprocessor

Pressing **RESET** lets you reset the microprocessor to its initial settings without changing the bookmark information.

The microprocessor must be reset under the following conditions:

- Prior to using this unit for the first time after installation
- If the unit fails to operate properly
- When strange or incorrect messages appear on the display

#### 1 Turn the ignition switch OFF.

#### 2 Press RESET with a pen tip or other pointed instrument.

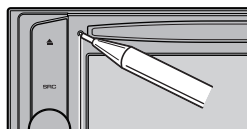

RESET button

#### Note

After completing connections or when you want to erase all memorized settings or return the unit to its initial (factory) settings, switch your engine ON or set the ignition switch to ACC ON before pressing **RESET**. 

## Feature demo mode

The feature demo automatically starts when you select the source **OFF**. The demo continues while the ignition switch is set to ACC or ON. To cancel the feature demo, press and hold **VOLUME/MUTE**. To restart the feature demo, press and hold **VOLUME/MUTE** again. Remember that if the feature demo continues operating when the car engine is turned off, it may drain battery power.



### Important

The red lead (ACC) of this unit should be connected to a terminal coupled with ignition switch on/off operations. If this is not done, the vehicle battery may be drained. 

## Operating this unit

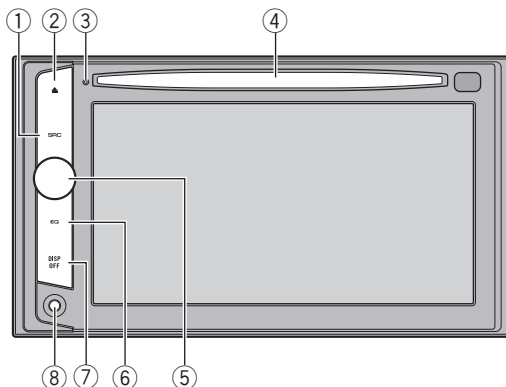

## What's What

### Head unit

#### ① SRC button

This unit is turned on by selecting a source. Press to cycle through all the available sources.

#### ② ▲ (eject) button

Press to eject a disc from this unit.

#### ③ RESET button

Press to return to the factory settings (initial settings).

#### ④ Disc loading slot

Insert a disc to play.

#### ⑤ VOLUME/MUTE button

Rotate it to increase or decrease the volume.  
Press to cut the sound.

#### ⑥ EQ button

Press to select various equalizer curves.

#### ⑦ DISP OFF button

Press to turn the information display on or off.

#### ⑧ AUX1 input jack (3.5 mm stereo/video jack)

Use to connect an auxiliary device.

## Optional remote control

*The remote control CD R55 is sold separately.*

For details concerning operations, see the remote control manual. 

## Basic Operations

### Power ON/OFF

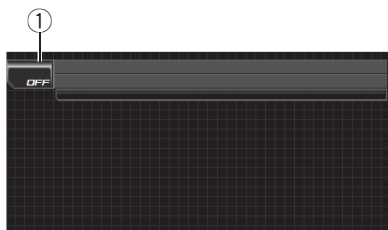

① Source icon

### Turning the unit on

- When using the touch panel keys, touch the source icon and then touch the desired source name.

The source names are displayed and selectable ones are highlighted.

- When using the button, press SRC to turn the unit on.

### Turning the unit off

- When using the touch panel keys, touch the source icon and then touch OFF.

- When the source icon is not displayed, you can display it by touching the screen.

- When using the button, press SRC and hold until the unit turns off.

### Selecting a source

You can select a source you want to listen to. To switch to the DVD player, load a disc in the unit. To switch to the iPod or USB, connect an iPod or USB portable audio player/USB memory to this unit.

- When using the touch panel keys, touch the source icon and then touch the desired source name.

The source names are displayed and selectable ones are highlighted.

- **DVD** Built in DVD player

- **RADIO** Radio
- **iPod** iPod
- **USB** USB portable audio player/USB memory
- **TEL** Bluetooth telephone
- **BT Audio** Bluetooth audio player
- **S-DVD** DVD player/multi DVD player
- **MCD** Multi CD player
- **AUX 1** AUX 1
- **AUX 2** AUX 2
- **AV** AV input
- **TV** Television
- **EXT 1** External unit 1
- **EXT 2** External unit 2
- **XM** XM tuner
- **SIRIUS** SIRIUS tuner
- **REARVIEW** Rear view camera
- **OFF** Turn the unit off
  - When the source icon is not displayed, you can display it by touching the screen.
  - While operating the menu, you cannot select a source by touching the source icon.
  - To close source select menu, touch **ESC**.
- When using the button, press SRC repeatedly to select a desired source.

### Notes

- In the following cases, the sound source will not change.
  - When no unit corresponding to the selected source is connected.
  - When there is no disc or magazine in the player.
  - When AUX (auxiliary input) is set to off (refer to page 38).
  - When the AV (AV input) is not set to **VIDEO** (refer to page 42).
- AUX1 is set to **VIDEO** by default. Set the AUX1 to **OFF** when not in use (refer to *Switching the auxiliary setting* on page 38).
- **REARVIEW** (rear view camera) cannot be selected by pressing **SRC**.
- Image from rear view camera can be displayed automatically when the appropriate setting is conducted. For details, refer to *Setting for rear view camera (back up camera)* on page 43.



## Operating this unit

- External unit refers to a Pioneer product (such as ones available in the future) that, although incompatible as a source, enables control of basic functions with this unit. Two external units can be controlled with this unit. When two external units are connected, the external unit is automatically allocated to external unit 1 or external unit 2 by this unit.
- When this unit's blue/white lead is connected to the vehicle's auto antenna relay control terminal, the vehicle's antenna extends when this unit's source is turned on. To retract the antenna, turn the source off.

### Adjusting the volume

- Use **VOLUME/MUTE** to adjust the sound level.

Rotate **VOLUME/MUTE** to increase or decrease the volume.

### Touch panel key basic operation

#### Activating the touch panel keys



- Touch panel keys  
Touch to do various operations.

#### 1 Touch the screen to activate the touch panel keys corresponding to each source.

- The touch panel keys appear on the display.
- To go to the next group of touch panel keys, touch **NEXT**.
  - To return to the previous group of touch panel keys, touch **PREV**.

#### 2 Touch HIDE to hide the touch panel keys.



If you do not use the touch panel keys within 30 seconds, they will be hidden automatically when selecting video sources.

### Operating the menu

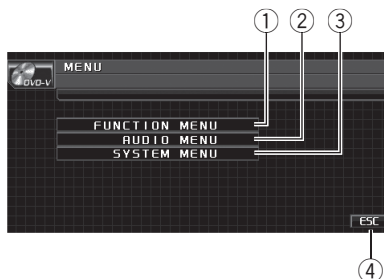

- FUNCTION MENU** key  
Touch to select functions for each source.
- AUDIO MENU** key  
Touch to select various sound quality controls.
- SYSTEM MENU** key  
Touch to select various setup functions.
- ESC** key  
Touch to cancel the control mode of functions.

#### 1 Touch AV MENU to display MENU.

The menu names are displayed and operable ones are highlighted.

- When **AV MENU** is not displayed, you can display it by touching the screen.

#### 2 Touch the desired key to display the function names you want to operate.

- To go to the next group of function names, touch **NEXT**.
- To return to the previous group of function names, touch **PREV**.

#### 3 Touch ESC to return to the display of each source.

## Radio

### Basic Operations

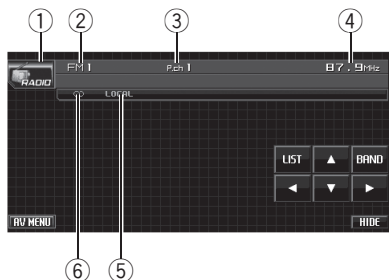

- ① Source icon
- ② Band indicator
- ③ Preset number indicator
- ④ Frequency indicator
- ⑤ **LOCAL** indicator  
Appears when local seek tuning is on.
- ⑥ (stereo) indicator  
Appears when the selected frequency is being broadcast in stereo.

**1 Touch the source icon and then touch RADIO to select the radio.**

**2 Touch BAND to select a band.**  
Touch **BAND** until the desired band (**FM1**, **FM2**, **FM3** for FM or **AM**) is displayed.

**3 To perform manual tuning, briefly touch ◀ or ▶.**

**4 To perform seek tuning, keep touching ◀ or ▶ for about one second and release.**  
The tuner will scan the frequencies until a broadcast strong enough for good reception is found.

- You can cancel seek tuning by briefly touching either ◀ or ▶.
- If you keep touching ◀ or ▶ you can skip stations. Seek tuning starts as soon as you release the key.



#### Note

Listening AM radio while an iPod is charged from this unit may generate noise. In this case, turn

the iPod charge setting off and noise is disappeared. (Refer to *Switching the iPod charge setting* on page 43.)

### Storing and recalling broadcast frequencies

You can easily store up to six broadcast frequencies for later recall.

- Up to 18 FM stations, six for each of the three FM bands, and six AM stations can be stored in memory.

**1 Touch LIST to display the preset list.**

**2 When you find a frequency that you want to store in memory keep touching one of preset tuning keys P1 to P6 until the beep sounds.**

The selected radio station frequency has been stored in memory.

The next time you touch the same preset tuning key the radio station frequency is recalled from memory.

**3 Touch ESC to return to the ordinary display.**



#### Note

You can also use ▲ and ▼ to recall radio station frequencies assigned to preset tuning keys **P1** to **P6**.

### Introduction of advanced operations

**1 Touch AV MENU and then touch FUNCTION MENU to display the function names.**

The function names are displayed and operable ones are highlighted.

**2 Touch ESC to return to the frequency display.**

- To return to the previous display, touch **BACK**.

## Operating this unit

### Storing the strongest broadcast frequencies

BSM (best stations memory) lets you automatically store the six strongest broadcast frequencies under preset tuning keys **P1** to **P6** and once stored there you can tune in to those frequencies with the touch of a key.

- Storing broadcast frequencies with BSM may replace broadcast frequencies you have saved using **P1** to **P6**.

#### ● Touch BSM on the function menu to turn BSM on.

**BSM** begins to flash. While **BSM** is flashing the six strongest broadcast frequencies will be stored under preset tuning keys **P1** to **P6** in order of their signal strength. When finished, **BSM** stops flashing.

- To cancel the storage process, touch **BSM** again.

### Tuning in strong signals

Local seek tuning lets you tune in only those radio stations with sufficiently strong signals for good reception.

#### ● Touch LOCAL on the function menu to set the sensitivity.

Touch **LOCAL** repeatedly until the desired level of sensitivity appears in the display.

There are four levels of sensitivity for FM and two levels for AM:

FM: **OFF LEVEL1 LEVEL2 LEVEL3 LEVEL4**

AM: **OFF LEVEL1 LEVEL2**

The **LEVEL4** setting allows reception of only the strongest stations, while lower settings let you receive progressively weaker stations. 

### Built-in DVD player

#### Basic Operations

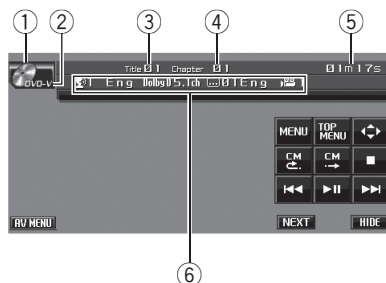

- Source icon
- Media indicator  
Shows the type of disc currently playing.
- Title/Folder number indicator  
DVD: shows the title currently playing.  
Compressed audio and DivX: shows the folder currently playing.
- Chapter/track/file number indicator  
DVD: shows the chapter currently playing.  
Video CD and CD: shows the track currently playing.  
Compressed audio and DivX: shows the file currently playing.
- Play time indicator
- Variable message area  
DVD: shows the subtitle language, audio language and viewing angle.  
CD TEXT, compressed audio and DivX: shows the text information of currently playing disc.

#### 1 Insert a disc into the disc loading slot.

Playback will automatically start.

- Be sure to turn up the label side of a disc.**
- After a disc has been inserted, use touch panel keys to select the DVD player.
- When the automatic playback function is on, this unit will cancel the DVD menu and automatically start playback from the first chapter of the first title. Refer to *Automatic playback of DVDs* on page 25.
- With some DVD discs, a menu may be displayed. (Refer to *Operating the DVD menu* on page 21.)

## Operating this unit

- With a Video CD featuring the PBC (playback control) function, a menu is displayed. (Refer to *PBC playback* on the next page.)
  - To eject a disc, press **▲** (eject).

### 2 Touch the screen to display the touch panel keys.

### 3 When playing a compressed audio or DivX, touch **▲** or **▼** to select a folder.

- To return to folder **01** (ROOT), touch and hold **⏪**. However, if folder **01** (ROOT) contains no files, playback commences with folder **02**. **⏪** is displayed only when the list is operated.

### 4 To skip back or forward to another chapter/track, briefly touch **⏮** or **⏭**.

- During PBC playback, a menu may be displayed if you perform these operations.

### 5 To perform fast forward or reverse, keep touching **⏮** or **⏭**.

When DVD, DivX disc or Video CD is playing, if you keep touching **⏮** or **⏭** for five seconds, the icon **⏮** or **⏭** is highlighted.

When this happens, fast reverse/fast forward continues even if you release **⏮** or **⏭**. To resume playback at a desired point, touch **⏮**.

- When playing DVD video or Video CD, fast forward/fast reverse may not be possible at certain locations on some discs. If this happens, normal playback automatically resumes.



#### Notes

- If you do not use the touch panel keys within 30 seconds, they will be hidden automatically when displaying video image.
- Read the precautions for discs and player on *Handling guideline of discs and player* on page 86.
- If an error message such as **ERROR-02-XX** is displayed, refer to *Error messages* on page 83.
- If bookmark function is on, DVD playback resumes from the selected point. For more details, refer to *Resume playback (Bookmark)* on page 22.

- If a disc contains a mixture of various media file types such as DivX and MP3, you can switch between media file types to play. Refer to *Switching the media file type* on the next page.
- There is sometimes a delay between starting up disc playback and the sound being issued. When being read, **FORMAT READ** is displayed.
- When playing back files recorded as VBR (variable bit rate) files, the play time will not be correctly displayed if fast forward or reverse operations are used.
- When playing back WMA files, album title list does not appear.
- If the characters recorded on the disc are not compatible with this unit, those characters will not be displayed.

## Basic playback controls

The table below shows the basic controls for playing discs. The following chapters cover other playback features in more details.

Key	What it does
<b>▶  </b>	Starts playback, pauses a disc that's playing or restarts a paused disc.
<b>■</b>	Stops playback.
<b>⏮</b>	Skips to the start of the current track, chapter or file, then to previous tracks/chapters/files. <ul style="list-style-type: none"> <li>Performs fast reverse by touching and holding <b>⏮</b>.</li> </ul>
<b>⏭</b>	Skips to the next track, chapter or file. <ul style="list-style-type: none"> <li>Performs fast forward by touching and holding <b>⏭</b>.</li> </ul>



#### Note

You may find with some DVD or Video CD discs that some playback controls do not work in certain parts of the disc. This is not a malfunction.

## Operating this unit

### Switching the media file type

When playing a disc containing a mixture of various media file types such as DivX and MP3, you can switch between media file types to play.

- This unit allows playback of the following media file type recorded on CD R/RW/ROM discs.

- Audio data (CD DA)
- Compressed audio files (WMA/MP3/AAC)
- DivX video files

- In case of DVD R/RW/ROM, this unit does not allow playback of audio data (CD DA).

- **Touch MEDIA to switch between media file types.**

Touch **MEDIA** repeatedly to switch between the following media file types:

**CD** (audio data (CD DA))   **WMA/MP3/AAC** (compressed audio)   **DivX** (DivX video files)

### Operating the DVD menu

Some DVDs allow you to select from the disc contents using a menu.

- This function is available for DVD video.
- You can display the menu by touching **MENU** or **TOP MENU** while a disc is playing. Touching either of these keys again lets you start playback from the location selected from the menu. For details, refer to the instructions provided with the disc.

### Using DVD menu direct touch control

This function allows you to operate the DVD menu by touching the menu item directly.

- **Touch the desired menu item on the DVD menu directly.**
  - Depending on the contents of DVD discs, this function may not work properly. In this case, using touch panel keys operate the DVD menu.

### Using the touch panel keys

#### 1 Touch **◀▶** to display touch panel keys to operate the DVD menu.

- When the touch panel keys are not displayed, you can display them by touching the screen.
- To switch to the DVD menu direct touch control, touch **TOUCH**.

#### 2 Touch **▲, ▼, ◀** or **▶** to select the desired menu item.

#### 3 Touch **ENTER**.

Playback starts from the selected menu item.

- The way to display the menu differs depending on the disc.

### PBC playback

During playback of Video CDs featuring PBC (Playback Control), **PBC ON** is displayed. You can operate PBC menu with **10Key**.

- This function is available for Video CD.

#### 1 When PBC menu is displayed, touch **SEARCH** and then touch **10Key**.

- Depending on the discs, the menu may be two or more pages long. In such case, touch **◀◀** or **▶▶** to display the next or previous menu.

#### 2 Touch **0** to **9** corresponding to a menu number and then touch **ENTER** to start playback.

Playback starts from the selected menu item.

#### 3 Touch **ESC** to hide the touch panel keys.



#### Notes

- You can display the menu by touching **RETURN** during PBC playback. For details, refer to the instructions provided with the disc.
- PBC playback of Video CD cannot be cancelled.
- During playback of Video CDs featuring PBC (Playback Control), **PBC ON**, search and time search functions cannot be used nor can you select the range for repeat play.

## Playing DivX® VOD content

Some DivX VOD (video on demand) content may only be playable a fixed number of times. When you load a disc containing this type of DivX VOD content, the remaining number of plays is shown on screen and you then have the option of playing the disc (thereby using up one of the remaining plays), or stopping. If you load a disc that contains expired DivX VOD content (for example, content that has zero remaining plays), **Rental Expired.** is displayed.

- If your DivX VOD content allows an unlimited number of plays, then you may load the disc into your player and play the content as often as you like, and no message will be displayed.

### Important

- In order to play DivX VOD content on this unit, you first need to register the unit with your DivX VOD content provider. About your registration code, refer to *Displaying your DivX® VOD registration code* on page 37.
- DivX VOD content is protected by a DRM (Digital Rights Management) system. This restricts playback of content to specific, registered devices.

### ● If the message is displayed after loading a disc containing DivX VOD content, touch **PLAY**.

Playback of the DivX VOD content will start.

- To skip to the next file, touch **NEXT PLAY**.
- If you do not want to play the DivX VOD content, touch **STOP**.

## Skipping back or forward to another title

- This function is available for DVD.

### ● To skip back or forward to another title, touch **▲** or **▼**.

Touching **▲** skips to the start of the next title.

Touching **▼** skips to the start of the previous title.

Title numbers are displayed for eight seconds.

- To switch between groups of touch panel keys, touch **NEXT** or **PREV**.

## CM skip/CM back

This function skips a reproduced image for a specified time. If the currently playing disc contains commercials, it is possible to skip them.

- This function is available for DVD.

### ● To skip progressively backward or forward, touch **⏮** or **⏭**

Each time you touch **⏮** or **⏭** it changes steps in the following order:

#### CM back

5 sec. 15 sec. 30 sec. 1.0 min. 2.0 min. 3.0 min. 0 sec.

#### CM skip

30 sec. 1.0 min. 1.5 min. 2.0 min. 3.0 min. 5.0 min. 10.0 min. 0 sec.

## Resume playback (Bookmark)

The Bookmark function lets you resume playback from a selected scene the next time the disc is loaded.

- This function is available for DVD video.

### ● During playback, touch **BOOKMARK** at the point you want to resume playback next time.

The selected scene will be bookmarked so that playback resumes from that point next time.

You can bookmark up to five discs. After that, the oldest bookmark is replaced by the new one.

- To switch between groups of touch panel keys, touch **NEXT** or **PREV**.
- To clear the bookmark on a disc, keep touching **BOOKMARK** during playback.

## Operating this unit

- You can also bookmark a disc by pressing and holding **EJECT** at the point you want to bookmark. Next time you load the disc, playback will resume from the bookmarked point. Note that you can only bookmark one disc using this method. To clear the bookmark on a disc, press **EJECT**.

### Searching for the part you want to play

You can use the search function to find the part you want to play.

- This function is available for DVD, DivX disc and Video CD.
- Chapter search, track search and time search are not possible when disc playback has been stopped.
- During playback of Video CDs featuring PBC (playback control), this function can not be operated.

#### 1 Touch **SEARCH**.

- To switch between groups of touch panel keys, touch **NEXT** or **PREV**.

#### 2 Touch the desired search option (e.g., **CHAP**).

- You cannot operate this step during DivX disc playback.

#### 3 Touch **0** to **9** to input the desired number.

- To cancel the inputted numbers, touch **C**.
- In the time search function, to select 1 hour 11 minutes, convert the time into 71 minutes 00 seconds and touch **7**, **1**, **0** and **0** in that order.

#### 4 Touch **ENTER**.

This starts playback from the selected part.



#### Note

With DVD discs featuring a menu, you can also touch **MENU** or **TOP MENU** and then make selections from the displayed menu.

### Changing audio language during playback (Multi-audio)

DVDs can provide audio playback with different languages and different systems (Dolby Digital, DTS etc.). With DVDs featuring multi audio recordings, you can switch between languages/audio systems during playback.

- This function is available for DVD and DivX disc.
- **Touch AUDIO during playback.** Each time you touch **AUDIO** it switches between audio systems.
  - To switch between groups of touch panel keys, touch **NEXT** or **PREV**.



#### Notes

- With some DVDs, switching between languages/audio systems may only be possible using a menu display.
- You can also switch between languages/audio systems using **DVD SETUP**. For details, refer to *Setting the audio language* on page 35.
- Only digital output of DTS audio is possible. If this unit's optical digital outputs are not connected, DTS audio will not be output, so select an audio setting other than DTS.
- Display indications such as **Dolby D** and **5.1ch** indicate the audio system recorded on the DVD. Depending on the setting, playback may not be with the same audio system as that indicated.
- Touching **AUDIO** during fast forward/fast reverse, pause or slow motion playback returns you to normal playback.

### Changing the subtitle language during playback (Multi-subtitle)

With DVDs featuring multi subtitle recordings, you can switch between subtitle languages during playback.

- This function is available for DVD and DivX disc.

## Operating this unit

### ● Touch **SUBTITLE** during playback.

Each time you touch **SUBTITLE** it switches between subtitle languages.

- To switch between groups of touch panel keys, touch **NEXT** or **PREV**.

### Notes

- With some DVDs, switching between subtitle languages may only be possible using a menu display.
- You can also switch between subtitle languages using **DVD SETUP**. For details, refer to *Setting the subtitle language* on page 35.
- Touching **SUBTITLE** during fast forward/fast reverse, pause or slow motion playback returns you to normal playback.

## Changing the viewing angle during playback (Multi-angle)

With DVDs featuring multi angle (scenes shot from multiple angles) recordings, you can switch among viewing angles during playback.

- This function is available for DVD video.
- During playback of a scene shot from multiple angles, the angle icon  is displayed. Turn angle icon display on or off using **DVD SETUP**. For details, refer to *Setting the angle icon display* on page 36.

### ● Touch **ANGLE** during playback of a scene shot from multiple angles.

Each time you touch **ANGLE** it switches between angles.

- To switch between groups of touch panel keys, touch **NEXT** or **PREV**.

### Note

Touching **ANGLE** during fast forward/fast reverse, pause or slow motion playback returns you to normal playback.

## Frame-by-frame playback

This lets you move ahead one frame at a time during playback.

- This function is available for DVD and Video CD.

### ● Touch **II▶** during playback.

Each time you touch **II▶**, you move ahead one frame.

- To return to normal playback, touch **▶II**.
- To switch between groups of touch panel keys, touch **NEXT** or **PREV**.
- With some discs, images may be unclear during frame by frame playback.

## Slow motion playback

This lets you slow down playback speed.

- This function is available for DVD and Video CD.

### ● Keep touching **II▶** until **▶▶** is displayed during playback.

The icon **▶▶** is displayed, forward slow motion playback begins.

- Touching **II▶** during slow motion playback, you can change the playback speed in four steps as follows:

1/16 1/8 1/4 1/2

- To switch between groups of touch panel keys, touch **NEXT** or **PREV**.
- To return to normal playback, touch **▶II**.

### Notes

- There is no sound during slow motion playback.
- With some discs, images may be unclear during slow motion playback.
- Reverse slow motion playback is not possible.

## Return to the specified scene

You can return to the specified scene where the DVD you are currently playing has been preprogrammed to return.

- This function is available for DVD video.

### ● Touch **RETURN** to return to the specified scene.

- To switch between groups of touch panel keys, touch **NEXT** or **PREV**.



## Operating this unit

- If a specified scene has not been programmed in DVD disc, this function is not possible.

### Automatic playback of DVDs

When a DVD disc with DVD menu is inserted, this unit will cancel the DVD menu automatically and start playback from the first chapter of the first title.

- This function is available for DVD video.
- Some DVDs may not operate properly. If this function is not fully operated, turn this function off and start playback.

#### ● Touch **AUTO PLAY** to turn automatic playback on.

- To turn automatic playback off, touch **AUTO PLAY** again.
- To switch between groups of touch panel keys, touch **NEXT** or **PREV**.
- When the automatic playback is on, you can not operate repeating play of DVD disc (refer to *Repeating play* on the next page).

### Text information

Text information recorded on a disc can be displayed. Text information is displayed on variable message area.

- This function is available for CD TEXT, compressed audio disc and DivX disc.

### Displaying text information

#### ● Touch **INFO**.

Touch **INFO** repeatedly to switch between the following settings:

##### For CD TEXT discs

🎵: disc title   🎤: disc artist name   🎶: track title   🎸: track artist name

##### For compressed audio discs

📁: folder name   📄: file name   🎧: album title   🎶: track title   🎤: artist name

##### For DivX discs

📁: folder name   📄: file name



#### Notes

- Some discs have certain information encoded on the disc during manufacture. These discs may contain such information as the CD title,

track title, artist's name and playback time and are called CD TEXT discs.

- If specific information has not been recorded on a CD TEXT disc, **No XXXX** will be displayed (e.g., **No name**).
- If specific information has not been recorded on a compressed audio disc, **No XXXX** will be displayed (e.g., **NO name**).
- When playing back WMA files, album title is not displayed.

### Selecting tracks from the track list

Track list lets you see the list of tracks on a disc and select one of them to play back.

When playing a CD TEXT disc, track titles are displayed.

- This function is available for CD.

#### 1 Touch **LIST**.

#### 2 Touch **↕** or **↔** to switch between the lists of tracks.

#### 3 Touch your favorite track.

That selection will begin to play.

#### 4 Touch **ESC** to return to the ordinary display.

### Selecting files from the file name list

File name list lets you see the list of file names (or folder names) and select one of them to playback.

- This function is available for compressed audio disc and DivX disc.

#### 1 Touch **LIST**.

#### 2 Touch **↕** or **↔** to switch between the lists of titles.

#### 3 Touch your favorite file name (or folder name).

That selection will begin to play.

- When you have selected a folder, a list of the names of the files (or the folders) in it can be viewed. Repeat steps 2 and 3 to select the desired file name.
- To return to the previous list (the folder one level higher), touch **↶**.

## Operating this unit

- To return to folder **01** (ROOT), touch and hold **⏮**. However, if folder **01** (ROOT) contains no files, playback commences with folder **02**.

### 4 Touch ESC to return to the ordinary display.

## Introduction of advanced operations

### 1 Touch AV MENU and then touch FUNCTION MENU to display the function names.

The function names are displayed and operable ones are highlighted.

### 2 Touch ESC to return to the playback display.

- To return to the previous display, touch **BACK**.

## Repeating play

Tracks in a play range are played repeatedly. Play range varies depending on the media. For DVD, play range can be selected from **DISC** (disc repeat), **TITLE** (title repeat) and **CHAPTER** (chapter repeat).

For Video CD and CD, play range can be selected from **DISC** (disc repeat) and **TRACK** (track repeat).

For compressed audio and DivX, play range can be selected from **DISC** (disc repeat), **FOLDER** (folder repeat) and **FILE** (file repeat).

- During playback of Video CDs featuring PBC (playback control), this function can not be operated.

### ● Touch REPEAT on the function menu to select the repeat range.

- **TITLE** Repeat the current title
- **CHAPTER** Repeat the current chapter
- **TRACK** Repeat the current track
- **FILE** Repeat just the current file
- **FOLDER** Repeat the current folder
- **DISC** Play through the current disc



### Notes

- If you perform chapter search or fast forward/reverse, the repeat play range changes to **DISC**.

- If you select another folder during repeat play, the repeat play range changes to **DISC**.
- When playing back compressed audio or DivX, if you perform track search or fast forward/reverse during **FILE**, the repeat play range changes to **FOLDER**.
- When playing back Video CD or CD, if you perform track search or fast forward/reverse during **TRACK**, the repeat play range changes to **DISC**.
- When **FOLDER** is selected, it is not possible to play back a subfolder of that folder.
- When playing discs with compressed audio and audio data (CD DA), repeat play performs within the currently playing data type even if **DISC** is selected.

## Playing tracks in random order

Tracks in a selected repeat range are played in random order.

- This function is available for CD and compressed audio disc.

### 1 Select the repeat range.

Refer to *Repeating play* on this page.

### 2 Touch RANDOM on the function menu to turn random play on.

Tracks will play in a random order within the previously selected repeat range.

- To turn random play off, touch **RANDOM** again.

## Scanning tracks or folders

Scan play lets you hear the first 10 seconds of each track on the CD.

When playing the compressed audio disc, the first 10 seconds of each track of the current folder (or the first track of each folder) is played.

- This function is available for CD and compressed audio disc.

### 1 Select the repeat range.

Refer to *Repeating play* on this page.

### 2 Touch SCAN on the function menu to turn scan play on.

The first 10 seconds of each track is played.

## Operating this unit

3 When you find the desired track (or folder) touch **SCAN** again.



### Note

After track or folder scanning is finished, normal playback of the tracks will begin again.

## Selecting audio output

When playing DVD video discs recorded with LPCM audio, you can switch the audio output. When playing Video CD discs, you can switch between stereo and monaural audio output.

- This function is available for DVD and Video CD.
- This function is not possible when disc playback has been stopped.
- If you select **Linear PCM**, when playing a disc recorded on a dual mono mode, you can operate this function. (Refer to *Setting for digital output* on page 38.)

### ● Touch L/R SELECT on the function menu to select the audio output.

Touch **L/R SELECT** repeatedly until the desired audio output appears in the display.

- **L+R** left and right
- **LEFT** left
- **RIGHT** right
- **MIX** mixing left and right



### Note

Depending on the disc and the playback location on the disc, the function may not be selectable, indicating that operating this function is not possible.

## Using compression

Using the COMP (compression) function lets you adjust the sound playback quality of this unit.

### ● Touch COMPRESSION on the function menu to select your favorite setting.

OFF COMP1 COMP2

## Playing songs on iPod

### Basic Operations

You can use this unit to control an iPod by using a cable (e.g., CD I200), which is sold separately.

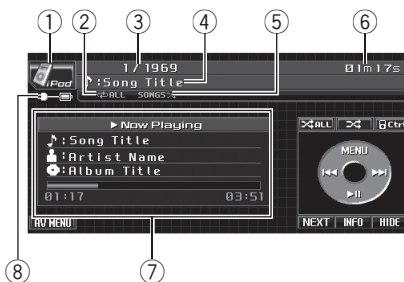

- ① Source icon
- ② Repeat indicator  
Shows when repeat range is set to **ONE** or **ALL**.
- ③ Song number indicator
- ④ Title indicator
- ⑤ Shuffle indicator  
Shows when random play is set to **SONGS** or **ALBUMS**.
- ⑥ Play time indicator
- ⑦ Song information  
Shows detailed information of currently playing song.
- ⑧ Battery charging indicator  
Shows when the battery charge setting is on.

### 1 Connect the iPod to this unit.

Playback will automatically start. While connected to this unit, **PIONEER, Accessory Attached** or ✓ (check mark) is displayed on the iPod.

- Before connecting the dock connector of this unit to the iPod, disconnect the headphones from the iPod.
- Depending on the model of iPod or the data size in the iPod, there may be a delay to start playing after connection.
- After the iPod has been connected to this unit, use touch panel keys to select the iPod.
- When removing the iPod from this unit, this unit is turned off.

### 2 To skip back or forward to another song, touch ◀◀ or ▶▶.

## Operating this unit

**3 To perform fast forward or reverse, keep touching I◀◀ or ▶▶I.**

**4 When playing a file with chapter, touch I◀◀ or ▶▶I to select a chapter.**

- To switch between groups of touch panel keys, touch **NEXT** or **PREV**.



### Notes

- Read the precautions for iPod on page 90.
- If an error message or icon such as **ERROR-11** or  is displayed, refer to *Error messages* on page 83.
- Connect directly the dock connector cable to the iPod so that this unit works properly.
- When the ignition switch is set to ACC or ON, the iPod's battery is charged while the iPod is connected to this unit.
- While the iPod is connected to this unit, the iPod cannot be turned on or off.
- The iPod is turned off about two minutes after the ignition switch is set to OFF.

## Playing video

This unit can play video if an iPod with video capabilities is connected.

- To pause video playback, touch **MENU**.
- This unit can play back "Movies", "Music videos", "Video Podcast" and "TV show" which are downloaded from iTunes store.
- Change the video setting on the iPod so that the iPod can output the video to an external device, before you display the video screen.
- For details, refer to the iPod's manuals.

**1 Touch Video.**

- To return to the music operation screen, touch **Music**.

**2 Play video on the iPod.**

## Browsing for a song/video

Operations to control an iPod with this unit is designed to be as close to the iPod as possible to make operation and song/video search easy.

- If the characters recorded on the iPod are not compatible with this unit, those characters are not displayed.

**1 Touch MENU to display iPod menus.**

**2 Touch one of the categories in which you want to search for a song/video.**

**When browsing for a song**

- **PLAYLISTS** (playlists)
- **ARTISTS** (artists)
- **ALBUMS** (albums)
- **SONGS** (songs)
- **PODCASTS** (podcasts)
- **GENRES** (genres)
- **COMPOSERS** (composers)
- **AUDIOBOOKS** (audiobooks)



**When browsing for a video**

- **V.PLAYLISTS** (playlists)
- **MOVIES** (movies)
- **MUSICVIDEOS** (music video)
- **V.PODCASTS** (video podcasts)
- **TV SHOWS** (TV shows)

- To switch between groups of categories, touch **PREV** or **NEXT**.

**3 Touch a list title that you want to play.**



Repeat this operation until you find the desired song/video.

- You can start playback throughout the selected list by touching and holding desired list title.
- You can start a playback of all the songs in the selected list (**GENRES**, **ARTISTS**, **COMPOSERS** or **ALBUMS**). To do this, touch **ALL**.
- You can start a playback of all the videos in the selected list (**MUSICVIDEOS** or **TV SHOWS**). To do this, touch **ALL**.
- To switch between the lists of titles, touch  or .
- To return to the previous menu, touch **MENU**.

**4 Touch ESC to return to the ordinary display.**

## Displaying text information on iPod

● **Touch INFO to select the desired text information.**

- : song title : artist name : album title
- If the characters recorded on the iPod are not compatible with this unit, those characters are not displayed.

## Operating this unit

### Repeating play

For playback of the songs on the iPod, there are two repeat play ranges: **ONE** (repeat one song) and **ALL** (repeat all songs in the list).

- While repeat play range is set to **ONE**, you cannot select the other songs. However, you can select other songs while browsing.

#### 1 Touch **NEXT**.

#### 2 Touch **↺** to select the repeat range.

- **ONE** Repeat just the current song
- **ALL** Repeat all songs in the selected list
- To switch between groups of touch panel keys, touch **NEXT** or **PREV**.

### Playing songs in a random order (shuffle)

For playback of songs on the iPod, there are two random play methods: **SONGS** (play back songs in a random order) and **ALBUMS** (play back albums in a random order).

#### ● Touch **↻** to select the random play method.

- **SONGS** Play back songs in the selected list in random order.
- **ALBUMS** Play back songs from a randomly selected album in order.
- To cancel the random play, touch **↻** repeatedly until the shuffle icon is turned off.

### Playing all songs in a random order (shuffle all)

This method plays all songs on the iPod randomly.

#### ● Touch **↻ALL** to turn shuffle all on.

All songs on the iPod play randomly.

### Operating this unit's iPod function from your iPod

This unit's iPod function can be operated from your iPod. Sound can be heard from car's speaker, and operation can be conducted from your iPod.

- While this function is in use, even if the ignition key is turned off, iPod is not turned off. To turn off power, operate the iPod.

#### 1 Touch **⏮** **Ctrl** to switch the control mode.

- Touching **⏮** **Ctrl** switches the control mode to this unit.
- While using this function, play time and titles are not displayed on this unit.
- Even if this function is performed, track up/down, chapter up/down and fast forward/reverse can be operated from this unit.
- While using this function, browse function cannot be operated from this unit.

#### 2 Operate the connected iPod to select a song/video and play.

### Pausing a song

#### ● Touch **⏸** during playback.

- To resume playback at the same point that you turned pause on, touch **⏸** again.

### Selecting songs from album list of currently playing artist

Album list of the currently selected artist is displayed. You can select an album or song from the artist name.

- This function is not available for video files.
- Depending on the number of files in the iPod, there may be a delay when displaying a list.

#### 1 Touch **NEXT**.

#### 2 Touch **LINK SEARCH** to turn link search on.

Searches albums of the artist and displays the list.

#### 3 Touch a list title that you want to play.

For more details about the selecting operation, refer to step 3 of *Browsing for a song/video* on the previous page.



#### Note

If link search is aborted, **NOT FOUND** is displayed.

## Changing audiobook speed

While listening to an audiobook on iPod, play back speed can be changed.

### ● Touch **A.Book** to select your favorite setting.

- **FASTER** Playback faster than normal speed
  - **NORMAL** Playback in normal speed
  - **SLOWER** Playback slower than normal speed
- To switch between groups of touch panel keys, touch **NEXT** or **PREV.** 

## Playing songs on USB portable audio player/USB memory

### Basic Operations

For details about the supported device, refer to *Portable audio player compatibility* on page 11.

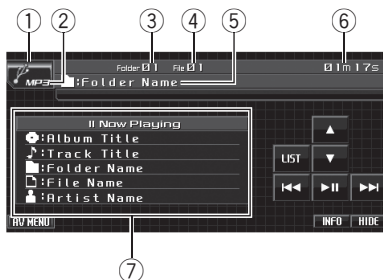



- ① Source icon
- ② Media indicator  
Shows the type of file currently playing.
- ③ Folder number indicator
- ④ File number indicator
- ⑤ Title indicator
- ⑥ Play time indicator
- ⑦ Song information  
Shows detailed information of currently playing song.

### 1 Touch the source icon and then touch **USB** to select the USB.

- When the source icon is not displayed, you can display it by touching the screen.

### 2 Touch **▲** or **▼** to select a folder.

- To return to folder **01** (ROOT), touch and hold . However, if folder **01** (ROOT) contains no files, playback commences with folder **02**.  is displayed only when the list is operated.
- You cannot select a folder that does not have a compressed audio file recorded in it.

### 3 To perform fast forward or reverse, keep touching **⏮** or **⏭**.

### 4 To skip back or forward to another compressed audio file, briefly touch **⏮** or **⏭**.

## Operating this unit



### Notes

- Optimum performance of this unit may not be obtained depending on the connected USB portable audio player/USB memory.
- If folder 01 (ROOT) contains no files, playback commences with folder 02.
- When the USB portable audio player having battery charging function is connected to this unit and the ignition switch is set to ACC or ON, the battery is charged.
- You can disconnect the USB portable audio player/USB memory anytime you want to finish listening to it.
- If USB portable audio player/USB memory is connected to this unit, the source is changed to USB automatically. If you do not use an USB device, disconnect it from this unit. Depending on the connected USB device, turning on the ignition switch while USB device is connected to this unit may change the source automatically.

## Pausing compressed audio playback

- **Touch ►II during playback.**
  - To resume playback at the same point that you turned pause on, touch ►II again.

## Introduction of advanced operations

### 1 Touch AV MENU and then touch FUNCTION MENU to display the function names.

The function names are displayed and operable ones are highlighted.

### 2 Touch ESC to return to the playback display.

- To return to the previous display, touch **BACK**.

## Function and operation

**REPEAT**, **RANDOM** and **SCAN** operations are basically the same as that of the built in DVD player.

Function name	Operation
<b>REPEAT</b>	Refer to <i>Repeating play</i> on page 26. However, the repeat play ranges you can select are different from that of the built in DVD player. The repeat play ranges of the USB portable audio player/USB memory are: <ul style="list-style-type: none"> <li>• <b>FILE</b> Repeat just the current file</li> <li>• <b>FOLDER</b> Repeat the current folder</li> <li>• <b>ALL</b> Repeat all files</li> </ul>
<b>RANDOM</b>	Refer to <i>Playing tracks in random order</i> on page 26.
<b>SCAN</b>	Refer to <i>Scanning tracks or folders</i> on page 26.



### Notes

- If you select another folder during repeat play, the repeat play range changes to **ALL**.
- If you perform track search or fast forward/reverse during **FILE**, the repeat play range changes to **FOLDER**.
- When **FOLDER** is selected, it is not possible to play back a subfolder of that folder.
- After file or folder scanning is finished, normal playback of the files begins again.

## Displaying text information of an audio file

The operation is the same as that of the built in DVD player.

Refer to *Text information* on page 25.

- If the characters recorded on the audio file are not compatible with this unit, those characters will not be displayed.

## Selecting files from the file name list

The operation is the same as that of the built in DVD player.

Refer to *Selecting files from the file name list* on page 25. ■

## Audio Adjustments

### Introduction of audio adjustments

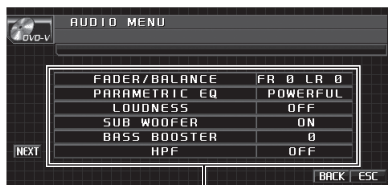

- ① Audio display  
Shows the audio adjustment status.

### Important

If the multi channel processor (DEQ P8000) is connected to this unit, the audio function will be changed to the multi channel processor's audio menu. For details, refer to *Introduction of DSP adjustments* on page 70.

#### 1 Touch AV MENU and then touch AUDIO MENU to display the audio function names.

The audio function names are displayed and operable ones are highlighted.

- To go to the next group of function names, touch **NEXT**.
- To return to the previous group of function names, touch **PREV**.
- When selecting FM and Bluetooth telephone as the source, you cannot switch to **SLA**.

#### 2 Touch ESC to return to the ordinary display.

- To return to the previous display, touch **BACK**.

### Using balance adjustment

You can change the fader/balance setting so that it can provide the ideal listening environment in all occupied seats.

#### 1 Touch FADER/BALANCE on the audio function menu.

- When the rear output setting is **S.W.**, **BALANCE** will be displayed instead of **FADER/BALANCE**. Refer to *Setting the rear output and subwoofer controller* on page 39.

#### 2 Touch ▲ or ▼ to adjust front/rear speaker balance.

Each time you touch ▲ or ▼ it moves the front/rear speaker balance towards the front or the rear.

**FRONT:15** to **REAR:15** is displayed as the front/rear speaker balance moves from front to rear.

- **FR: 0** is the proper setting when only two speakers are used.
- When the rear output setting is **S.W.**, you cannot adjust front/rear speaker balance. Refer to *Setting the rear output and subwoofer controller* on page 39.

#### 3 Touch ◀ or ▶ to adjust left/right speaker balance.

Each time you touch ◀ or ▶ it moves the left/right speaker balance towards the left or the right.

**LEFT:15** to **RIGHT:15** is displayed as the left/right speaker balance moves from left to right.

### Using the equalizer

The equalizer lets you adjust the equalization to match the car's interior acoustic characteristics as desired.

#### Recalling equalizer curves

There are six stored equalizer curves which you can easily recall at any time. Here is a list of the equalizer curves.

Display	Equalizer curve
POWERFUL	Powerful
NATURAL	Natural
VOCAL	Vocal
CUSTOM	Custom
FLAT	Flat
SUPER BASS	Super bass

- **CUSTOM** is an adjusted equalizer curve that you create. If you make adjustments to an equalizer curve, the equalizer curve setting is memorized in **CUSTOM**.



## Operating this unit

- When **FLAT** is selected, no supplement or correction is made to the sound. This is useful to check the effect of the equalizer curves by switching alternatively between **FLAT** and a set equalizer curve.
- Press **EQ** to select the equalizer. Press **EQ** repeatedly to switch between the following equalizers:  
**POWERFUL NATURAL VOCAL CUSTOM**  
**FLAT SUPER BASS**

### Adjusting equalizer curves

You can adjust the center frequency and the Q factor (curve characteristics) of each currently selected curve band (**LOW/MID/HIGH**).

- The actual range of the adjustments are different depending on which equalizer curve is selected.

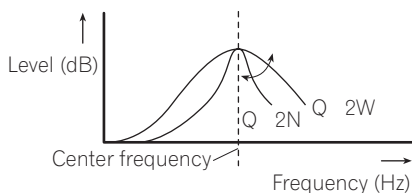

- Touch **PARAMETRIC EQ** on the audio function menu.
- Touch **◀** or **▶** next to **EQ SELECT** to select an equalizer curve.  
**POWERFUL NATURAL VOCAL CUSTOM**  
**FLAT SUPER BASS**
- Touch **◀** or **▶** next to **BAND** to select the equalizer band to adjust.  
**LOW** (low) **MID** (mid) **HIGH** (high)
- Touch **◀** or **▶** next to **FREQUENCY** to select the frequency to adjust.  
Low: **40Hz 80Hz 100Hz 160Hz**  
Mid: **200Hz 500Hz 1kHz 2kHz**  
High: **3.15kHz 8kHz 10kHz 12.5kHz**
- Touch **◀** or **▶** next to **Q.FACTOR** to select the Q factor.  
**2W 1W 1N 2N**

### 6 Touch ▲ or ▼ to adjust the level of the equalizer band.

**+12dB** to **-12dB** is displayed as the level is increased or decreased.

- You can then select another band and adjust the level.

### Adjusting loudness

Loudness compensates for deficiencies in the low and high sound ranges at low volume.

- Touch **LOUDNESS** on the audio function menu.
- Touch **▶** to turn loudness on.
  - To turn loudness off, touch **◀**.
- Touch **◀** or **▶** to select a desired level.  
**LOW** (low) **MID** (mid) **HIGH** (high)

### Using subwoofer output

This unit is equipped with a subwoofer output which can be turned on or off.

- When the subwoofer output is on, you can adjust the cut off frequency and the output level of the subwoofer.

- Touch **SUB WOOFER** on the audio function menu.
- Touch **▶** next to **SUB WOOFER** to turn subwoofer output on.
  - To turn subwoofer output off, touch **◀**.
- Touch **◀** or **▶** next to **PHASE** to select the phase of subwoofer output. Touch **▶** to select normal phase and **NORMAL** appears in the display. Touch **◀** to select reverse phase and **REVERSE** appears in the display.
- Touch **◀** or **▶** next to **LEVEL** to adjust the output level of the subwoofer. **+6** to **-24** is displayed as the level is increased or decreased.
- Touch **◀** or **▶** next to **FREQUENCY** to select cut-off frequency. Each time you touch **◀** or **▶** selects cut off frequencies in the following order:  
**50Hz 63Hz 80Hz 100Hz 125Hz**

## Operating this unit

Only frequencies lower than those in the selected range are outputted from the subwoofer.

### Boosting the bass

Bass boost function boosts the bass level of sound.

**1 Touch BASS BOOSTER on the audio function menu.**

**2 Touch ◀ or ▶ to select a desired level.**

**0 to +6** is displayed as the level is increased or decreased.

### Using the high pass filter

When you do not want low sounds from the subwoofer output frequency range to play from the front or rear speakers, turn on the HPF (high pass filter). Only frequencies higher than those in the selected range are output from the front or rear speakers.

**1 Touch HPF on the audio function menu.**

**2 Touch ▶ next to HPF to turn high pass filter on.**

- To turn high pass filter off, touch ◀.

**3 Touch ◀ or ▶ next to FREQUENCY to select cut-off frequency.**

Each time you touch ◀ or ▶ selects cut off frequencies in the following order:

**50Hz 63Hz 80Hz 100Hz 125Hz**

Only frequencies higher than those in the selected range are outputted from the front or rear speakers.

### Adjusting source levels

SLA (source level adjustment) lets you adjust the volume level of each source to prevent radical changes in volume when switching between sources.

- Settings are based on the FM volume level, which remains unchanged.

**1 Compare the FM volume level with the level of the source you wish to adjust.**

**2 Touch NEXT on the audio function menu.**

**3 Touch SLA.**

**4 Touch ◀ or ▶ to adjust the source volume.**

Each time you touch ◀ or ▶ it increases or decreases the source volume.

**+4 to -4** is displayed as the source volume is increased or decreased.



#### Notes

- The AM volume level can also be adjusted with source level adjustments.
- Video CD, CD, compressed audio and DivX are set to the same source level adjustment volume automatically.
- External unit 1 and external unit 2 are set to the same source level adjustment volume automatically. 

## Operating this unit

### Setting up the DVD player

#### Introduction of DVD setup adjustments

You can use this menu to change audio, subtitle, parental lock and other DVD settings.

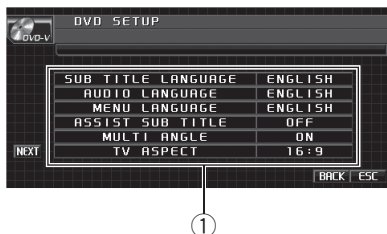

- ① DVD setup menu display  
Shows the DVD setup menu names.

#### 1 Touch **■**.

**SETUP** will be displayed instead of **MENU**.

#### 2 Touch **SETUP**.

The DVD setup function names are displayed.

- To go to the next group of function names, touch **NEXT**.
- To return to the previous group of function names, touch **PREV**.

#### 3 Touch **ESC** to return to the playback display.

- To return to the previous display, touch **BACK**.

### Setting the subtitle language

You can set a desired subtitle language. If the selected subtitle language is recorded on the DVD, subtitles are displayed in that language.

#### 1 Touch **SUB TITLE LANGUAGE** on the DVD setup menu.

A subtitle language menu is displayed.

#### 2 Touch the desired language.

A subtitle language is set.

- To switch to the second language select menu, touch **NEXT**.
- To return to the first language select menu, touch **PREV**.
- If you have selected **OTHERS**, refer to *When you select OTHERS* on this page.

#### Notes

- If the selected language is not recorded on the disc, the language specified on the disc is displayed.
- You can also switch the subtitle language by touching **SUBTITLE** during playback. (Refer to *Changing the subtitle language during playback (Multi subtitle)* on page 23.)
- Even if you use **SUBTITLE** during playback to switch the subtitle language, this does not affect the settings here.

#### When you select **OTHERS**

When you select **OTHERS**, a language code input display is shown. Refer to *Language code chart for DVD* on page 92 to input the four digit code of the desired language.

#### 1 Touch **0** to **9** to input the language code.

- To cancel the inputted numbers, touch **C**.

#### 2 Touch **ENTER**.

### Setting the audio language

You can set the preferred audio language.

#### 1 Touch **AUDIO LANGUAGE** on the DVD setup menu.

An audio language menu is displayed.

#### 2 Touch the desired language.

The audio language is set.

- To switch to the second language select menu, touch **NEXT**.
- To return to the first language select menu, touch **PREV**.
- If you have selected **OTHERS**, refer to *When you select OTHERS* on this page.

#### Notes

- If the selected language is not recorded on the disc, the language specified on the disc is outputted.
- You can also switch the audio language by touching **AUDIO** during playback. (Refer to *Changing audio language during playback (Multi audio)* on page 23.)

- Even if you use **AUDIO** during playback to switch the audio language, this does not affect the settings here.

## Setting the menu language

You can set the preferred language for displays of menus recorded on a disc.

### 1 Touch **MENU LANGUAGE** on the **DVD setup menu**.

A menu language menu is displayed.

### 2 Touch the desired language.

The menu language is set.

- To switch to the second language select menu, touch **NEXT**.
- To return to the first language select menu, touch **PREV**.
- If you have selected **OTHERS**, refer to *When you select OTHERS* on the previous page.



#### Note

If the selected language is not recorded on the disc, the language specified on the disc is displayed.

## Switching the assist subtitle on or off

If assist subtitles are recorded on a DVD disc, you can display them by turning the assist subtitle function on.

You can turn assist subtitles on or off as desired.

### ● Touch **ASSIST SUBTITLE** on the **DVD setup menu to turn assist subtitles on**.

- To turn the assist subtitle off, touch **ASSIST SUBTITLE** again.

## Setting the angle icon display

You can set it up so that the angle icon appears on scenes where the angle can be switched.

- Initially, this function is set to on.
- Touch **MULTI ANGLE** on the **DVD setup menu to turn angle icon display on**.
  - To turn the angle icon display off, touch **MULTI ANGLE** again.

## Setting the aspect ratio

There are two kinds of display. A wide screen display has a width to height ratio (TV aspect) of 16:9, while a regular display has a TV aspect of 4:3. Be sure to select the correct TV aspect for the display connected to **REAR MONITOR OUTPUT**.

- When using a regular display, select either **LETTER BOX** or **PAN SCAN**. Selecting **16:9** may result in an unnatural picture.
- If you select the TV aspect, the unit's display changes to the same setting.

### ● Touch **TV ASPECT** on the **DVD setup menu to select the TV aspect**.

Touch **TV ASPECT** repeatedly until the desired TV aspect appears in the display.

- **16:9** Wide screen picture (16:9) is displayed as it is (initial setting)
- **LETTER BOX** The picture is the shape of a letterbox with black bands at the top and bottom of the screen
- **PAN SCAN** The picture is cut short at the right and left of the screen



#### Notes

- When playing discs that do not specify **PAN SCAN**, playback is with **LETTER BOX** even if you select **PAN SCAN** setting. Confirm whether the disc package bears the **16:9 LB** mark. (See page 13.)
- Some discs do not enable changing of the TV aspect. For details, refer to the disc's instructions.

## Setting the parental lock

Some DVD video discs let you use parental lock to restrict children from viewing violent and adult oriented scenes. You can set the parental lock to your desired level.

- When you set a parental lock level and then play a disc featuring parental lock, code number input indications may be displayed. In this case, playback will begin when the correct code number is input.

## Setting the code number and level

You need to have registered a code number for playing back discs with parental lock.

## Operating this unit

### 1 Touch NEXT on the DVD setup menu.

### 2 Touch PARENTAL.

### 3 Touch 0 to 9 to input a four digit code number.

- To cancel the inputted numbers, touch **C**.

### 4 Touch ENTER.

The code number is set, and you can now set the level.

### 5 Touch any of 1 to 8 to select the desired level.

The parental lock level is set.

- **LEVEL 8** Playback of the entire disc is possible (initial setting)
- **LEVEL 7 to LEVEL 2** Playback of discs for children and non adult oriented discs is possible
- **LEVEL 1** Playback of discs for children only is possible

#### Notes

- We recommend to keep a record of your code number in case you forget it.
- The parental lock level is recorded on the disc. Look for the level indication written at the disc package, included literature or on the disc it self. Parental lock of this unit is not possible if a parental lock level is not recorded in the disc.
- With some discs, the parental lock may be active only on the scenes with certain levels. The playback of those scenes will be skipped. For details, refer to the instruction manual that came with the discs.

## Changing the level

You can change the set parental lock level.

### 1 Touch NEXT on the DVD setup menu.

### 2 Touch PARENTAL.

### 3 Touch 0 to 9 to input the registered code number.

### 4 Touch ENTER.

This enters the code number, and you can now change the level.

- If you input an incorrect code number, the icon  is displayed. Touch **C** and input the correct code number.

- If you forget your code number, refer to *If you forget your code number* on this page.

### 5 Touch any of 1 to 8 to select the desired level.

The new parental lock level is set.

## If you forget your code number

Refer to *Changing the level* on this page, and touch **C** 10 times. The registered code number is canceled, letting you register a new one.

## Setting the DivX subtitle file

You can select whether to display DivX external subtitles or not.

- The DivX subtitles will be displayed even when **CUSTOM** is selected if no DivX external subtitle files exist.

### 1 Touch NEXT on the DVD setup menu.

### 2 Touch DivX SUB TITLE to select the desired subtitle setting.

- **ORIGINAL** Display the DivX subtitles
- **CUSTOM** Display the DivX external subtitles

#### Notes

- Up to 42 characters can be displayed on one line. If more than 42 characters are set, the line breaks and the characters are displayed on the next line.
- Up to 126 characters can be displayed on one screen. If more than 126 characters are set, the excess characters will not be displayed.

## Displaying your DivX® VOD registration code

In order to play DivX VOD (video on demand) content on this unit, you first need to register the unit with your DivX VOD content provider. You do this by generating a DivX VOD registration code, which you submit to your provider.

### 1 Touch NEXT on the DVD setup menu.

## 2 Touch DivX VOD.

Your 8 digit registration code is displayed.

- Make a note of the code as you will need it when you register with a DivX VOD provider.

## Setting for digital output

Audio which is outputted from digital output of this unit can be selected. Normally, set to **STREAM**. If this unit's digital output is not used, there is no need to change settings.

- Selecting **Linear PCM** enables you to switch the output channel if playing the following type of discs. (Refer to *Selecting audio output* on page 27.)  
Dual mono mode DVD video discs

### 1 Touch NEXT on the DVD setup menu.

### 2 Touch DIGITAL OUTPUT to select the desired digital output setting.

- **STREAM** The Dolby Digital/DTS signal is output as it is (initial setting)
- **Linear PCM** The Dolby Digital/DTS signal is converted to and output as a linear PCM signal

## Initial Settings

### Adjusting initial settings

Using the initial settings, you can customize various system settings to achieve optimal performance from this unit.

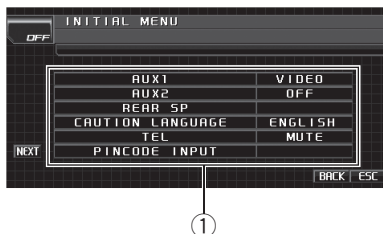

- ① Function display  
Shows the function names.

### 1 Touch the source icon and then touch OFF to turn this unit off.

### 2 Touch the screen to display the touch panel keys.

### 3 Touch AV MENU and then touch INITIAL MENU to display the function names.

The function names are displayed and operable ones are highlighted.

- To go to the next group of function names, touch **NEXT**.
- To return to the previous group of function names, touch **PREV**.

### 4 Touch ESC to return to the ordinary display.

- To return to the previous display, touch **BACK**.

## Switching the auxiliary setting

Auxiliary devices connected to this unit can be activated individually. Set each AUX source to ON when using. For more information about connecting or using auxiliary devices, refer to *Using the AUX source* on page 45.

## Operating this unit

### Switching the auxiliary 1 setting

- **Touch AUX1 on the initial menu to select desired setting.**
  - **VIDEO** an iPod with video capabilities connected with 4 pole mini plug cable (e.g., CD V150M)
  - **AUDIO** auxiliary device connected with stereo mini plug cable
  - **OFF** No auxiliary device is connected

### Switching the auxiliary 2 setting

- **Touch AUX2 on the initial menu to turn auxiliary 2 setting on.**
  - To turn auxiliary 2 setting off, touch **AUX2** again.

### Setting the rear output and subwoofer controller

This unit's rear output (rear speaker leads output and RCA rear output) can be used for full range speaker (**FULL**) or subwoofer (**S.W**) connection. If you switch the rear output setting to **S.W**, you can connect a rear speaker lead directly to a subwoofer without using an auxiliary amp.

Initially, the unit is set for rear full range speaker connection (**FULL**). When rear output is connected to full range speakers (when **FULL** is selected), you can connect other full range speakers (**REAR**) or a subwoofer (**S.W**) to the RCA rear output.

- When the multi channel processor (e.g., DEQ P8000) is connected to this unit, you cannot operate this function.

#### 1 Touch REAR SP on the initial menu.

#### 2 Touch ◀ or ▶ next to REAR SP to switch the rear output setting.

Touch ◀ to select full range speaker and **FULL** appears in the display. Touch ▶ to select subwoofer and **S.W** appears in the display.

- When no subwoofer is connected to the rear output, select **FULL** (full range speaker).
- When a subwoofer is connected to the rear output, select **S.W** (subwoofer).
- When the rear output setting is **S.W**, you can not operate the following procedure.

#### 3 Touch ◀ or ▶ next to PREOUT to switch the subwoofer output or rear output.

Touching ◀ or ▶ will switch between **S.W** and **REAR** and that status will be displayed.



#### Notes

- Even if you change this setting, there is no output unless you turn the subwoofer output on (refer to *Using subwoofer output* on page 33).
- If you change this setting, subwoofer output in the audio menu return to the factory settings.
- Both rear speaker lead outputs and RCA rear output are switched simultaneously in this setting.

### Changing languages for CAUTION

Some operations on this unit are prohibited while driving or needs to be paid a careful attention when operating. In such case, a caution appears on the display. You can change the language of the cautions at this setting.

- **Touch CAUTION LANGUAGE on the initial menu to select your desired language.** Each time you touch **CAUTION LANGUAGE** it selects languages for CAUTION in the following order:

**ENGLISH ESPAÑOL FRANÇAIS**

### Switching the sound muting/attenuation

Sound from this system is muted or attenuated automatically when the signal from the equipment with mute function is received.

- Sound from this system returns to normal when the muting or attenuation is canceled.

- **Touch TEL to select any of the muting, attenuation or off.**

Touch **TEL** until the desired setting appears in the display.

- **MUTE** Muting
- **ATT-20dB** Attenuation (**ATT-20dB** has a stronger effect than **ATT-10dB**)
- **ATT-10dB** Attenuation

## Operating this unit

- **OFF** Turn the sound muting/attenuation off



### Notes

- The sound is turned off, **MUTE** is displayed and no audio adjustments are possible.
- The sound is attenuated, **ATT** is displayed and no audio adjustments, except volume control, are possible.
- Operation returns to normal when the phone connection is ended.

## Entering PIN code for Bluetooth wireless connection

To connect your cellular phone to this unit via Bluetooth wireless technology, you need to enter PIN code on your phone to verify the connection. The default code is **0000**, but you can change this in this function.

- With some Bluetooth audio players, you may be required to enter the Bluetooth audio player PIN code in advance to set this unit for a connection.
- You can only operate this function when Bluetooth adapter (e.g. CD BTB200) is connected to this unit.

**1 Touch NEXT on the initial menu.**

**2 Touch PINCODE INPUT.**

PIN code input display appears.

**3 Touch 0 to 9 to input the PIN code of your Bluetooth audio player.**

- To cancel the inputted numbers, touch **C**.

**4 After inputting PIN code (up to 16 digits), touch ENTER.**

The PIN code you entered is stored in this system.

## Correcting distorted sound

You can minimize distortion that may be caused by the equalizer curve settings.

Setting an equalizer level high can cause distortion. If high sound is crippled or distorted, try switching to **LOW**. Normally, leave the setting at **HIGH** to ensure quality sound.

- Only when the multi channel processor (e.g., DEQ P8000) is connected to this unit, you can operate this function.

**1 Touch NEXT on the initial menu.**

**2 Touch DIGITAL ATT to switch the digital attenuator setting.**

Touch **DIGITAL ATT** repeatedly until the desired setting appears in the display.

- **HIGH** High quality sound
- **LOW** Minimize distortion sound

## Resetting the audio functions

You can reset all audio functions except volume.

- Only when the multi channel processor (e.g., DEQ P8000) is connected to this unit, you can operate this function.

**1 Touch NEXT on the initial menu.**

**2 Touch AUDIO RESET.**

**3 Touch RESET.**

**4 Touch RESET again to reset audio functions.**

- To cancel resetting the audio functions, touch **CANCEL** 



## Operating this unit

### Other Functions

#### Introduction of system adjustments

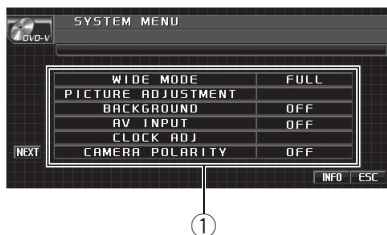

- ① System menu display  
Shows the system function names.

#### 1 Touch AV MENU and then touch SYSTEM MENU to display the system function names.

The system function names are displayed and operable ones are highlighted.

- To go to the next group of function names, touch **NEXT**.
- To return to the previous group of function names, touch **PREV**.

#### 2 Touch ESC to return to the display of each source.

- To return to the previous display, touch **BACK**.

### Changing the wide screen mode

You can select a desired mode for enlarging a 4:3 picture to a 16:9 one.

#### 1 Touch WIDE MODE on the system menu.

#### 2 Touch the desired wide mode setting.

#### 3 Touch ESC to hide the touch panel keys.

##### FULL (full)

A 4:3 picture is enlarged in the horizontal direction only, giving you a 4:3 TV picture (normal picture) without any omissions.

##### JUST (just)

The picture is enlarged slightly at the center and the amount of enlargement increases horizontally to the ends, enabling you to enjoy a 4:3 picture without sensing any disparity even on a wide screen.

##### CINEMA (cinema)

The picture is enlarged by the same proportion as **FULL** or **ZOOM** in the horizontal direction and by an intermediate proportion between **FULL** and **ZOOM** in the vertical direction; ideal for a cinema sized picture (wide screen picture) where captions lie outside.

##### ZOOM (zoom)

A 4:3 picture is enlarged in the same proportion both vertically and horizontally; ideal for a cinema sized picture (wide screen picture).

##### NORMAL (normal)

A 4:3 picture is displayed as it is, giving you no sense of disparity since its proportions are the same as that of the normal picture.



#### Notes

- Different settings can be memorized for each video source.
- When video is viewed in a wide screen mode that does not match its original aspect ratio, it may appear different.
- Remember that using the wide mode feature of this system for commercial or public viewing purposes may constitute an infringement on the author's rights protected by the Copyright Law.
- The video image will appear coarser when viewed in **CINEMA** or **ZOOM** mode.

### Changing the picture adjustment

You can adjust **BRIGHTNESS** (brightness), **CONTRAST** (contrast), **COLOR** (color) and **HUE** (hue) for each source and rear view camera.

- You cannot adjust **COLOR** or **HUE** for the audio source.

## Operating this unit

### 1 Touch PICTURE ADJUSTMENT on the system menu.

The adjustment function names are displayed.

### 2 Touch any of the following touch panel keys to select the function to be adjusted.

- **BRIGHTNESS** Adjust the black intensity
- **CONTRAST** Adjust the contrast
- **COLOR** Adjust the color saturation
- **HUE** Adjust the tone of color (red is emphasized or green is emphasized)
- **DIMMER** Adjust the brightness of display
- **REAR VIEW/SOURCE** Switch the picture adjustment modes
  - You cannot adjust the picture adjustment for rear view camera when **CAMERA POLARITY** is set to **OFF**. (Refer to *Setting for rear view camera (back up camera)* on the next page.)
  - With some rear view cameras, picture adjustment may not be possible.

### 3 Touch ◀ or ▶ to adjust the selected item.

Each time you touch ◀ or ▶ it increases or decreases the level of selected item. **+24** to **-24** is displayed as the level is increased or decreased.

### 4 Touch ESC to hide the touch panel keys.

## Adjusting the dimmer

To prevent the display from being too bright at night, the display is automatically dimmed when the car's headlights are turned on. You can turn the dimmer on or off.

### 1 Touch PICTURE ADJUSTMENT on the system menu.

The adjustment function names are displayed.

### 2 Touch DIMMER.

### 3 Touch ◀ or ▶ to adjust the brightness.

Each time you touch ◀ or ▶ it moves cursor towards the left or the right.

The level indicates the brightness of the screen being adjusted. The farther cursor moves to the right, the brighter the screen.

### 4 Touch ESC to hide the touch panel keys.

## Selecting the background display

You can switch background displays while listening to each source.

- You can enjoy **AV** (AV input) as the background video image while you are listening to audio source such as radio or CD.

### ● Touch BACKGROUND on the system menu to select the desired background display.

#### Audio source

**BGP1** (background picture 1) **BGP2** (background picture 2) **BGP3** (background picture 3) **AV** (AV input)

#### Video source

**OFF** (off) **BGP1** (background picture 1) **BGP2** (background picture 2) **BGP3** (background picture 3) **AV** (AV input)

- When the AV (AV input) is not set to **VIDEO**, **AV** cannot be selected. (Refer to this page.)

## Setting the AV input

You can switch the setting according to the connected component.

- Select **VIDEO** to watch video of a connected component as **AV** source.
- Select **S-DVD** to watch video of a connected DVD player as **S-DVD** source.
- Select **EXT-VIDEO** to watch video of a connected video unit as **EXT** source.
- Select **TV** to watch TV pictures from a connected TV tuner as **TV** source.

### ● Touch AV INPUT on the system menu to select the AV input setting.

- **OFF** No video component connected
- **VIDEO** External video component (such as portable video player)
- **S-DVD** DVD player connected with RCA cable
- **EXT-VIDEO** External video unit (such as Pioneer products available in the future)
- **TV** TV tuner connected with RCA cable

## Operating this unit

### Setting the clock

Use these instructions to set the clock.

#### 1 Touch **CLOCK ADJ** on the system menu.

#### 2 Touch **ON/OFF** to turn the clock display on.

- To turn the clock display off, touch **ON/OFF** again.

#### 3 Touch **◀** or **▶** to select the segment of the clock display you wish to set.

Each time you touch **◀** or **▶** it will select one segment of the clock display:

Hour Minute

As you select segments of the clock display the segment selected will be highlighted.

#### 4 Touch **▲** or **▼** to put a clock right.

#### Notes

- You can match the clock to a time signal by touching **JUST**.
  - If **00** to **29**, the minutes are rounded down. (e.g., **10:18** becomes **10:00**.)
  - If **30** to **59**, the minutes are rounded up. (e.g., **10:36** becomes **11:00**.)
- Even when the sources are off, the clock display appears on the display.

### Setting for rear view camera (back up camera)

#### CAUTION

**Pioneer recommends the use of a camera which outputs mirror reversed images, otherwise screen image may appear reversed.**

This unit features a function that automatically switches to the rear view camera video (**REAR CAMERA IN** jack) when a rear view camera is installed on your vehicle. When the gear shift is in **REVERSE (R)** position, the video automatically switches to a rear view camera video. (For more details, consult your dealer.)

- After you set up the rear view camera setting, move the gear shift in **REVERSE (R)**

and confirm if a rear view camera video can be shown on the display.

- If the display should be switched to a rear view camera video by error while you are driving forward, change the rear view camera setting.
- To end watching a rear view camera video and return to the source display, press and hold **VOLUME/MUTE**.
- Even while driving, rear view camera image can be displayed. To do this, touch **REARVIEW** source icon. In this case, touch **REARVIEW** again to turn off the rear view camera. For details, refer to *Selecting a source* on page 16.

#### ● Touch **CAMERA POLARITY** on the system menu to select an appropriate setting.

- **BATTERY** When the polarity of the connected lead is positive while the gear shift is in **REVERSE (R)** position
- **GROUND** When the polarity of the connected lead is negative while the gear shift is in **REVERSE (R)** position
- **OFF** When a rear view camera is not connected to this unit

### Switching the iPod charge setting

You can turn the iPod charge setting on or off while listening to an iPod.

- Listening AM radio while an iPod is charged from this unit may generate noise. In this case, turn the iPod charge setting off and noise is disappeared.
- Initially, this function is set to on.

#### 1 Touch **NEXT** on the system menu.

#### 2 Touch **iPod CHARGE** to turn the iPod charge setting on.

- To turn the iPod charge setting off, touch **iPod CHARGE** again.

#### Note

For maximum performance, we recommend that you use the latest version of the iPod software.

## Selecting the OSD color

You can change the OSD color.

- **Touch OSD COLOR to select the desired color.**

Each time you touch **OSD COLOR** it selects colors in the following order:

**BLUE** (blue) **RED** (red) **AMBER** (amber)  
**GREEN** (green) **VIOLET** (violet)

## Selecting the illumination color

This unit is equipped with multiple color illumination. You can select a desired color from 112 different types of color.

### Direct selection from preset illumination color

You can select an illumination color from the color list.

#### 1 Touch ILLUMI COLOR to display the setting menu.

#### 2 Touch one of the color list.

You can select one from the following list.

- **BLUE** (blue)
- **RED** (red)
- **AMBER** (amber)
- **GREEN** (green)
- **VIOLET** (violet)
- **SCAN** (scanning all colors)



#### Note

**SCAN** setting cycles continuously through all the colors.

## Customizing the illumination color

#### 1 Touch ILLUMI COLOR to display the setting menu.

#### 2 Touch to display the customizing menu.

#### 3 Rotate VOLUME/MUTE to customize the color.

#### 4 To store the customized color in memory, touch and hold one of preset keys 1 to 3 until the beep sounds.

The customized color has been stored in memory.

The next time you touch the same preset key, the color is recalled from memory.

## Adjusting the response positions of the touch panels (Touch Panel Calibration)

If you feel that the touch panel keys on the screen deviate from the actual positions that respond to your touch, adjust the response positions of the touch panel. There are two adjustment methods: 4 point adjustment, in which you touch four corners of the screen; and 16 point adjustment, in which you make fine adjustments on the entire screen.

- Make sure to use the supplied pen for adjustment, and gently touch the screen. If you press the touch panel forcefully, the touch panel may be damaged. Do not use a sharp pointed tool such as ballpoint pen or a mechanical pen. Otherwise the screen is damaged.
- If touch panel adjustment cannot be performed properly, consult your local Pioneer dealer.

#### 1 Touch the source icon and then touch OFF to turn this unit off.

- When the source icon is not displayed, you can display it by touching the screen.

#### 2 Press and hold (eject).

The 4 point touch panel adjustment screen appears.

#### 3 Touch each of the arrows on the four corners of the screen with the touch panel adjustment pen.

- To cancel the adjustment, press and hold **VOLUME/MUTE**.

## Operating this unit

### 4 Press EQ to complete the 4-point adjustment.

The adjusted position data is saved.

- Do not turn off the engine while saving the adjusted position data.

### 5 Press EQ to proceed to the 16-point adjustment.

The 16 point touch panel adjustment screen appears.

- To cancel the adjustment, press and hold **VOLUME/MUTE**.

### 6 Gently touch the center of the + mark displayed on the screen with the touch panel adjustment pen.

After you touch all the marks, the adjusted position data is saved.

- Do not turn off the engine while saving the adjusted position data.

### 7 Press and hold VOLUME/MUTE to complete the adjustment.

## Using the AUX source

A separately sold auxiliary device such as VCR or portable device can be connected to this unit. When connected, auxiliary device is automatically recognized as AUX source and as signed to **AUX**.

### About AUX connection method

You have two methods to connect auxiliary device to this unit.

#### Mini pin plug cable (AUX 1)

*When connecting auxiliary device using a mini plug cable*

iPod and portable audio/video player can be connected to this unit via mini plug cable.

- If an iPod with video capabilities is connected to this unit via 3.5 mm plug (4 pole) cable (e.g., CD V150M), you can enjoy the video contents of the iPod.

- It is possible to connect a portable audio/video player by using a 3.5 mm plug (4 pole) to RCA cable, which is sold separately. However, depending on the cable, reverse connection between Red (right side audio) cable and yellow (video) cable is required. Otherwise, audio and video may not be correctly reproduced.

#### ● Insert the stereo mini plug into the AUX input jack on this unit.

For more details, refer to *What's What* on page 15.

#### IP-BUS-RCA interconnector (AUX 2)

*When connecting auxiliary device using an IP BUS RCA Interconnector (sold separately)*

#### ● Use an IP-BUS-RCA Interconnector such as the CD-RB20/CD-RB10 (sold separately) to connect this unit to auxiliary device featuring RCA output.

For more details, refer to the IP BUS RCA Interconnector owner's manual.

- You can only make this type of connection if the auxiliary device has RCA outputs.

### Selecting AUX as the source

#### ● Touch the source icon and then touch AUX 1/AUX 2 to select AUX as the source.

- If the auxiliary setting is not turned on, **AUX** cannot be selected. For more details, see *Switching the auxiliary setting* on page 38.

### Setting the AUX title

The title displayed for the **AUX** source can be changed.

- Each title can be up to 10 characters long.

#### 1 After you have selected AUX as the source, touch AV MENU and FUNCTION MENU and then touch NAME EDIT.

- When the touch panel keys are not displayed, you can display them by touching the screen.

## Operating this unit

### 2 Touch ABC to select the desired character type.

Touch **ABC** repeatedly to switch between the following character types:

Alphabet (upper case)    Alphabet (lower case)

- You can select to input numbers and symbols by touching **123**.

### 3 Touch ▲ or ▼ to select a letter of the alphabet.

### 4 Touch ► to move the cursor to the next character position.

### 5 Touch OK to store the entered title in memory.

### 6 Touch ESC to return to the ordinary display.

## Using the external unit

External unit refers to a Pioneer product (such as ones available in the future) that, although incompatible as a source, enables control of basic functions with this unit. Two external units can be controlled with this unit. When two external units are connected, the external unit is automatically allocated to external unit 1 or external unit 2 by this unit.

Basic operations of the external unit are explained below. Allocated functions are different depending on the connected external unit. For details concerning functions, refer to external unit's owner's manual.

### Selecting the external unit as the source

- Touch the source icon and then touch **EXT 1/EXT 2** to select external unit as the source.

### Basic operation

Functions allocated to the following operations are different depending on the connected external unit. For details concerning functions, refer to the connected external unit's owner's manual.

- Touch **BAND**.
- Keep touching **BAND**.
- Touch ◀ or ▶.
- Keep touching ◀ or ▶.
- Touch ▲ or ▼.

### Using the functions allocated to 1 to 6 keys

- 1 Touch **NEXT**.
- 2 Touch any of 1 to 6 to select a function.

### Advanced operations

- 1 Touch **AV MENU** and then touch **FUNCTION MENU** to display the function names.

The function names are displayed and operable ones are highlighted.

- **FUNC1** (function 1)
- **FUNC2** (function 2)
- **FUNC3** (function 3)
- **FUNC4** (function 4)
- **AUTO/MANUAL** (auto/manual)

- 2 Touch **ESC** to return to the ordinary display.

- To return to the previous display, touch **BACK**.

## Using the PGM button

You can operate the preprogrammed functions for each source by using **PGM**.

- Only the optional remote control (e.g., CD R55) can operate this function.
- Press **PGM** to turn pause on when selecting the following sources:
  - **DVD** Built in DVD player
  - **iPod** iPod
  - **USB** USB portable audio player/USB memory
  - **S-DVD** DVD player/multi DVD player
  - **MCD** Multi CD player

## Operating this unit

- **BT Audio** Bluetooth audio player
  - To turn pause off, press **PGM** again.
- **Press PGM and hold to turn BSM on when selecting RADIO as the source.**

Press **PGM** and hold until the BSM turns on.

  - To cancel the storage process, press **PGM** again.
- **Press PGM and hold to turn BSSM on when selecting TV as the source.**

Press **PGM** and hold until the BSSM turns on.

  - To cancel the storage process, press **PGM** again.
- **Press PGM to select the desired channel select setting when selecting XM or SIRIUS as the source.**

Press **PGM** repeatedly to switch between the following channel select settings:

  - CH-NUMBER** (channel number select setting)
  - CATEGORY** (channel category select setting)

## XM tuner

### Basic Operations

You can use this unit to control an XM satellite digital tuner (GEX P920XM), which is sold separately.

For details concerning operation, refer to the XM tuner's operation manuals. This section provides information on XM operations with this unit which differs from that described in the XM tuner's operation manual.

- This unit does not have the text scroll function.
- With this unit, you can operate one additional function: XM channel direct selection.

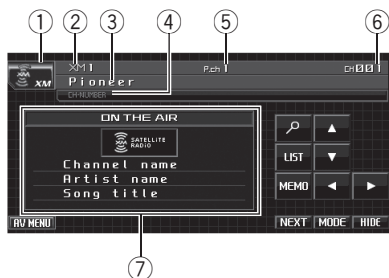

- ① Source icon
- ② XM band indicator
- ③ XM channel category
- ④ XM channel select setting indicator  
Shows what channel select setting has been selected.
- ⑤ XM preset number indicator
- ⑥ XM channel number indicator
- ⑦ Detail information  
Shows the detail information of the broadcast channel currently being received.

**1 Touch the source icon and then touch XM to select the XM.**

**2 Touch BAND to select an XM band.**

Touch **BAND** repeatedly until the desired XM band is displayed, **XM1**, **XM2** or **XM3**.

- To switch between groups of touch panel keys, touch **NEXT** or **PREV**.

**3 Touch ◀ or ▶ to select a desired channel.**

The channels move up or down step by step. Channels that cannot currently be selected are skipped, and the next channel is selected.

- If you touch and hold ◀ or ▶, you can increase or decrease the channel number continuously.
- You can also perform tuning from a desired channel category. (Refer to *Selecting a channel in the channel category* on the next page.)

### Storing and recalling broadcast stations

You can easily store up to six broadcast stations for later recall.

- Up to 18 stations, six for each of three XM bands can be stored in memory.

**1 Select the channel that you want to store in memory.**

**2 Touch LIST to display the preset list.**

**3 Touch and hold a preset tuning key P1 (PRESET1) to P6 (PRESET6) until the beep sounds.**

The selected station has been stored in memory.

The next time you touch the same preset tuning key **P1 (PRESET1)** to **P6 (PRESET6)** the station is recalled from memory.

**4 Touch ESC to return to the ordinary display.**



#### Note

You can also use ▲ and ▼ to recall stations as signed to preset tuning keys **P1 (PRESET1)** to **P6 (PRESET6)** when the **CH-NUMBER** mode is selected.



## Available accessories

### Switching the XM channel select mode

You have two methods for selecting a channel: by number and by category. When selecting by number, channels in any category can be selected. Select by category to narrow your search down to only channels in a particular category.

#### ● Touch **MODE** to select the desired channel select mode.

Touch **MODE** repeatedly to switch between the following channel select modes:

**CH-NUMBER** (channel number select setting)

**CATEGORY** (channel category select setting)

### Selecting a channel in the channel category

#### 1 Touch **MODE** to select the channel category select mode.

Touch **MODE** repeatedly to switch between the following channel select modes:

**CH-NUMBER** (channel number select setting)

**CATEGORY** (channel category select setting)

#### 2 Touch ▲ or ▼ to select the desired channel category.

#### 3 Touch ◀ or ▶ to select the desired channel in the selected channel category.

### Selecting a channel from the XM channel list display

The list content can be switched so you can search for the track you want to listen to not only by the channel name but also by the artist name or song title.

- This function is available for GEX P920XM.
- The channel list shows all the channels during the **CH-NUMBER** mode, and the channels included in the selected category during the **CATEGORY** mode. To switch the channel mode, touch **MODE**.

#### 1 Touch **⌂**.

XM channel list appears in the display.

Each touch of **⌂** changes the following settings as follows:

**CHANNEL NAME LIST** (channel name)

**SONG TITLE LIST** (song title)

**ARTIST NAME LIST** (artist name)

#### 2 Touch the desired channel that you want to listen to.

- To switch between the lists of names/titles, touch **↕** or **↔**.
- When the **CATEGORY** mode is selected, touch **▲** or **▼** to switch to another category.

### Selecting an XM channel directly

You can select an XM channel directly by entering the desired channel number.

#### 1 Touch **DIRECT**.

- To switch between groups of touch panel keys, touch **NEXT** or **PREV**.

#### 2 Touch **0** to **9** to input the desired channel number.

- To cancel the input numbers, touch **C**.

#### 3 Touch **ENTER**.

The XM channel of entered number is selected.

### Using the MyMix function

The MyMix function allows you to make the MyMix song playlist. When the song in the MyMix playlist is being broadcast on a station other than the one you are listening to, you will be alerted, and you can tune to the station to listen to that song.

- This function is available for GEX P920XM.
- A track itself is NOT downloaded BUT only the song title and the artist name are memorized.

## Making the MyMix playlist

You can add a song that is being broadcast to the MyMix playlist. When it is added, the song title and its artist name is memorized to this unit. The MyMix function will start on the song that matches the song title and its artist name in the MyMix playlist.

### 1 When a desired song is broadcast, touch and hold MEMO.

The song title and artist name of the song you are listening to are memorized, and a confirmation message appears.

- The song title and artist name of up to 12 tracks can be memorized. Trying to save more than 12 tracks will overwrite old ones.
- You cannot memorize the song title or the artist name when " " is displayed on the title information.
- You cannot memorize the song title or the artist name of the channel 000.
- It is possible that the memorized title is not displayed correctly.

### 2 Touch OK to confirm.

- To delete the song from the MyMix playlist, refer to *Deleting the song from the MyMix playlist* on this page.

## When the song in the MyMix playlist is broadcast

As soon as the song in the MyMix playlist starts broadcast on a different station, a message is displayed. Touch **YES** to switch to that station, and you can listen to that song.

- If you would rather not to tune to that station, touch **CANCEL**.
- If an alert for the song in the MyMix playlist is set up to off, no alert will be provided even when the song is broadcast. Refer to *Setting up a song alert* on page 54.
- If there is slight difference between the memorized title and the title of the song being broadcast, no alert will be provided even though they are the same song.

## Setting up a song alert

You can set up an alert on or off by each song in the MyMix playlist. First, display the MyMix playlist and then change each alert setting. Set up an alert to on so you can receive the alert when the song is broadcast, or set it up to off to stop the alert for that song.

### 1 Touch MEMO EDIT.

The MyMix playlist is displayed.

- To switch between groups of touch panel keys, touch **NEXT** or **PREV**.

### 2 Touch the song title that you want to set up the alert to off.

The check mark is removed, and the alert for that song is off.

## Deleting the song from the MyMix playlist

You can delete each song in the MyMix playlist.

### 1 Touch MEMO EDIT.

The MyMix playlist is displayed.

### 2 Touch DELETE next to the song title you want to delete.

That song will be deleted from the MyMix playlist.

- To delete all the songs in the MyMix playlist, touch **DELETE ALL**.

### 3 A message will appear asking you to confirm to delete it. Touch YES.

- To cancel the deleting, touch **NO**.

## Displaying the Radio ID

### Channel number select setting

If you select **CH000**, the ID code is displayed.

- Touch ◀ or ▶ to select **CH000**.

### Channel category select setting

**RADIO ID** is provided as a channel category for displaying the ID code.

## Available accessories

- Touch ▲ or ▼ to select RADIO ID from channel category.

Display of the ID code repeats displaying **RADIO ID** and the ID code one after the other.

- If you select another channel, display of the ID code is canceled.

### Switching the XM display

- This function is available for GEX P910XM.

- Touch **INFO** to switch the XM display.

Channel name Artist name/feature Song/  
program title Channel category 

## SIRIUS Satellite Radio tuner

### Basic Operations

You can use this unit to control a SIRIUS Satellite Radio tuner, which is sold separately.

When the SIRIUS tuner is used together with this unit, some operations differ slightly from those described in the SIRIUS operation manual. This manual provides information on these points. For all other information on using the SIRIUS tuner, please refer to the SIRIUS operation manual.

- This unit does not have the text scroll function.
- With this unit, you can operate one additional function: SIRIUS channel direct selection. Refer to *Selecting a SIRIUS channel directly* on page 53.

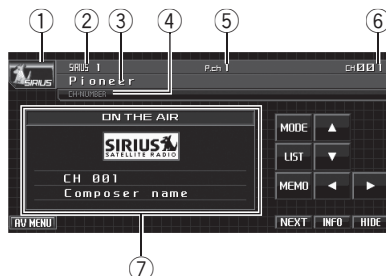

- ① Source icon
- ② SIRIUS band indicator
- ③ SIRIUS channel category
- ④ SIRIUS channel select setting indicator  
Shows what channel select setting has been selected.
- ⑤ SIRIUS preset number indicator
- ⑥ SIRIUS channel number indicator
- ⑦ Detail information  
Shows the detail information of the broadcast channel currently being received.

**1 Touch the source icon and then touch SIRIUS to select SIRIUS.**

**2 Touch BAND to select a band.**

Touch **BAND** repeatedly until the desired SIRIUS band is displayed, **SR1**, **SR2** or **SR3**.

## Available accessories

- To switch between groups of touch panel keys, touch **NEXT** or **PREV**.

### 3 Touch ◀ or ▶ to select a desired channel.

The channels move up or down step by step. Channels that cannot currently be selected are skipped, and the next channel is selected.

- If you touch and hold ◀ or ▶, you can increase or decrease the channel number continuously.
- You can also perform tuning from a desired channel category. (Refer to *Selecting a channel in the channel category* on this page.)



#### Note

It may take a few seconds before you can hear anything while this unit acquires and processes the satellite signal.

## Storing and recalling broadcast stations

You can easily store up to six broadcast stations for later recall.

- Up to 18 stations, six for each of three SIRIUS bands can be stored in memory.
- Channels are stored and recalled on a broadcast station basis. This means that if the broadcast station you stored has been assigned to a different channel by SIRIUS, you can still recall the same broadcast station (though a different channel number may appear in the display).

- 1 Select the channel that you want to store in memory.
- 2 Touch **LIST** to display the preset list.
- 3 Touch and hold a preset tuning key **PRESET1** to **PRESET6** until the beep sounds.

The selected station has been stored in memory.

The next time you touch the same preset tuning key **PRESET1** to **PRESET6** the station is recalled from memory.

### 4 Touch **ESC** to return to the ordinary display.



#### Note

You can also use ▲ and ▼ to recall stations assigned to preset tuning keys **PRESET1** to **PRESET6** when the **CH-NUMBER** mode is selected.

## Selecting the SIRIUS channel select mode

You have two methods for selecting a channel: by number and by category. When selecting by number, channels in any category can be selected. Select by category to narrow your search down to only channels in a particular category.

### ● Touch **MODE** to select the desired channel select mode.

Touch **MODE** repeatedly to switch between the following channel select modes:

- **CH-NUMBER** (channel number select setting)
- **CATEGORY** (channel category select setting)

## Selecting a channel in the channel category

Channels are organized into various program categories, e.g. Rock, Classic, Jazz. You can specify channels by selecting the desired category.

### 1 Touch **MODE** to select the channel category select mode.

Touch **MODE** repeatedly to switch between the following channel select modes:

- **CH-NUMBER** (channel number select setting)
- **CATEGORY** (channel category select setting)

### 2 Touch ▲ or ▼ to select the desired channel category.

### 3 Touch ◀ or ▶ to select the desired channel in the selected channel category.

## Available accessories

### Selecting a SIRIUS channel directly

You can select a SIRIUS channel directly by entering the desired channel number.

#### 1 Touch DIRECT.

- To switch between groups of touch panel keys, touch **NEXT** or **PREV**.

#### 2 Touch 0 to 9 to input the desired channel number.

- To cancel the input numbers, touch **C**.

#### 3 Touch ENTER.

The SIRIUS channel of entered number is selected.

### Using the MyMix function

The MyMix function allows you to make the MyMix song playlist. When the song in the MyMix playlist is being broadcast on a station other than the one you are listening to, you will be alerted, and you can tune to the station to listen to that song.

- This function is available for SIR PNR2/SIR PNR2C.
- A track itself is NOT downloaded BUT only the song title and the artist name are memorized.

### Making the MyMix playlist

You can add a song that is being broadcast to the MyMix playlist. When it is added, the song title and its artist name is memorized to this unit. The MyMix function will start on the song that matches the song title and its artist name in the MyMix playlist.

#### ● When a desired song is broadcast, touch and hold MEMO.

The song title and artist name of the song you are listening to are memorized, and a confirmation message appears.

- The song title and artist name of up to 10 tracks can be memorized. When you try to save more than 10 tracks, **FULL** is displayed and that song being broadcast cannot be saved.

- You cannot memorize the song title or the artist name of the channel 000.
- It is possible that the memorized title is not displayed correctly.

### When the song in the MyMix playlist is broadcast

As soon as the memorized song starts broadcast on a different station, a song alert is displayed. Touch **JUMP** to switch to that station, and you can listen to that track.

- If you would rather not to tune to that station, touch **STAY**.
- If an alert for the song in the MyMix playlist is set up to off, no alert will be provided even when the song is broadcast. Refer to *Setting up a song alert* on the next page.
- If there is slight difference between the memorized title and the title of the song being broadcast, no alert will be provided even though they are the same song.

### Turning the MyMix function on or off

You can turn the MyMix function off and stop this unit to alert you for all the songs in the MyMix playlist. To restart, turn this function on.

- The MyMix function is on at the default setting.

#### 1 Touch MEMO EDIT.

The display is switched to the memo edit mode.

- To switch between groups of touch panel keys, touch **NEXT** or **PREV**.

#### 2 Touch ALERT OFF to turn the MyMix function off.

The MyMix function is now off.

- To turn the MyMix function on, touch **ALERT ON**.

## Available accessories

### Setting up a song alert

You can set up an alert on or off by each song in the MyMix playlist. First, display the MyMix playlist and then change each alert setting. Set up an alert to on so you can receive the alert when the song is broadcast, or set it up to off to stop the alert for that song.

#### 1 Touch MEMO EDIT.

The display is switched to the memo edit mode.

- To switch between groups of touch panel keys, touch **NEXT** or **PREV**.

#### 2 Touch PREV or NEXT to select the song title that you want to turn the alert off.

#### 3 Touch ON/OFF to turn the alert off.

The alert for the song is turned off.

### Deleting the song from the MyMix playlist

You can delete each song in the MyMix playlist.

#### 1 Touch MEMO EDIT.

The song title in the MyMix playlist is displayed.

- To switch between groups of touch panel keys, touch **NEXT** or **PREV**.

#### 2 Touch PREV or NEXT to select the song title that you want to delete.

#### 3 Touch DELETE.

#### 4 A message will appear asking you to confirm to delete it. Touch YES.

The selected song is deleted.

- To cancel the deleting, touch **CANCEL**.

### Using the Game Alert function

This system can alert you when games involving your favorite teams are about to start. To use this function you need in advance to set up a game alert for the teams.

- This function is available for SIR PNR2/SIR PNR2C.

### Selecting teams for Game Alert

#### 1 Touch TEAM SET.

#### 2 Touch PREV or NEXT next to LEAGUE to select a desired league.

League names are switched in the display.

#### 3 Touch PREV or NEXT next to TEAM to select a desired team.

Teams in the selected category are switched in the display.

#### 4 Touch ON/OFF to store the selected team in memory.

**ON** is displayed with the selected team, and the Game Alert function will start on that team.

- To turn the Game Alert off of the selected team, touch **ON/OFF** again.
- When you have already made 12 team selections, **FULL** is displayed and additional team selection is not possible. In this case, first delete the team selection and then try again.

#### 5 Repeat these steps for selecting other teams.

Up to 12 teams can be selected.

### Switching the Game Alert on or off

Once you made team selections, you need to turn the Game Alert function on.

- The Game Alert function is on at the default setting.

#### 1 Touch TEAM SET.

#### 2 Touch ALERT ON to turn the Game Alert on.

The Game Alert function is now on.

- To turn the Game Alert function off, touch **ALERT OFF**.

## Available accessories

### When the game of the selected team starts

When a game of the selected team is about to start (or is currently playing) on a different station, a game alert is displayed. Touch **JUMP** to switch to that station, and you can listen to that game.

- If you would rather not to tune to that station, touch **STAY**.

### Displaying game information

If games of your selected teams are currently playing, you can display information of the games and tune to the broadcast channel.

#### 1 Touch **GAME INFO**.

The game information of your selected team is displayed.

#### 2 Touch **PREV** or **NEXT** to select a game.

The game is displayed, followed by more detailed game information.

- Game score will be updated automatically.

#### 3 Touch **TuneTO** to switch to that station to listen to the game.



#### Notes

- If you have not made any team selections, **NOT SET** is displayed.
- When games involving your favorite teams are not currently playing, **NO GAME** is displayed.

### Displaying the Radio ID

If you select **CH000**, the ID code is displayed.

#### ● Touch **◀** or **▶** to select **CH000**.

- To select **CH000**, set the channel select setting to **CH-NUMBER**. About the channel select setting, refer to *Selecting the SIRIUS channel select mode* on page 52.

### Switching the SIRIUS display

- This function is available for SIR PNR1.

#### ● Touch **INFO** to switch the SIRIUS display.

Channel name Artist name/feature Song/  
program title Channel category

### Using Instant Replay function

Following functions can be operated during the Instant Replay mode.

- To use this function, Pioneer SIRIUS bus interface (e.g. CD SB10) is required.
- To use this function, SIRIUS plug and play unit with Instant Replay Function is required.
- For details, refer to SIRIUS plug and play unit's manuals.

#### ● Touch **NEXT**.

#### ● Touch **INSTANT REPLAY**.

Instant Replay mode is displayed. Now, Instant Replay mode can be performed.

- In the following conditions, tuner exits from the Instant Replay mode.

When **LIVE** is touched

When another source is selected

#### ● Select a track

Touch **◀** or **▶**.

#### ● Pause and play

Touch **▶II**.

#### ● Fast forward or reverse

Touch and hold **◀** or **▶** for about one second and release.

## Bluetooth Audio

### Basic Operations

- If you connect a Bluetooth adapter (e.g. CD BTB200) to this unit, you can control Bluetooth audio players via Bluetooth wireless technology.
- In some countries, CD BTB200 is not sold on the market.

#### Important

- Depending on the Bluetooth audio player connected to this unit, the operations available with this unit are limited to the following two levels:

Lower level: Only playing back songs on your audio player is possible.

Higher level: Playing back, pausing, selecting songs, etc., are possible (all the operations illustrated in this manual).

- Since there are a number of Bluetooth audio players available on the market, operations with your Bluetooth audio player using this unit vary in great range. Refer to the instruction manual that came with your Bluetooth audio player as well as this manual while operating your player on this unit.
- Information about songs (e.g. the elapsed playing time, song title, song index, etc.) can not be displayed on this unit.
- While you are listening to songs on your Bluetooth audio player, refrain from operating on your cellular phone as much as possible. If you try operating your cellular phone, the signal from your cellular phone may cause noise on the song playback.
- When you are talking on a cellular phone connected to this unit via Bluetooth wireless technology, song playback from your Bluetooth audio player connected to this unit is muted.
- Even if while you are listening to a song on your Bluetooth audio player and you switch to another source, playback of song continues.

For details concerning operation, refer to the Bluetooth adapter's operation manual. This

section provides brief information on Bluetooth audio player operations with this unit, which slightly differs or is abbreviated from that described in the Bluetooth adapter's operation manual.

- Even though your audio player does not contain a Bluetooth module, you can still control it from this unit via Bluetooth wireless technology. To control your audio player using this unit, connect a product featuring Bluetooth wireless technology (available on the market) to your audio player and connect the Bluetooth adapter (e.g. CD BTB200) to this unit.

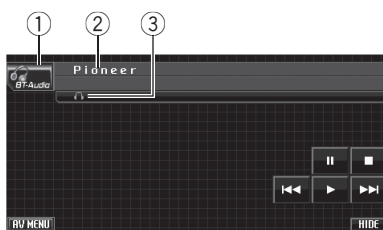

- ① Source icon
- ② Device name  
Shows the device name of the connected Bluetooth audio player (or Bluetooth adapter).
- ③ Connection indicator  
Shows the Bluetooth wireless connection status.

#### 1 Touch the source icon and then touch BT Audio to select the Bluetooth audio source.

- For this unit to control your Bluetooth audio player it needs to establish a Bluetooth wireless connection. (Refer to *Connecting a Bluetooth audio player* on the next page.)

#### 2 Touch ►.

Playback starts.

#### 3 To skip back or forward to another track, briefly touch ◀◀ or ▶▶.

#### 4 To perform fast forward or reverse, keep touching ◀◀ or ▶▶.



## Available accessories

5 To stop playback, touch ■.

### Pausing playback

- Touch II during playback.
  - To resume playback at the same point that you turned pause on, touch ►.

### Introduction of advanced operations

1 Touch AV MENU and then touch FUNCTION MENU to display the function names.

The function names are displayed and operable ones are highlighted.

2 Touch ESC to return to the ordinary display.

- To return to the previous display, touch BACK.

### Connecting a Bluetooth audio player

● Touch CONNECTION OPEN on the function menu to turn the connection open on.

CONNECTION WAITING is displayed. This unit is now on standby for connection from Bluetooth audio player.

If your Bluetooth audio player is set ready for Bluetooth wireless connection, connection to this unit is automatically established.

#### Note

Before you can use audio players you may need to enter the PIN code into this unit. If your player requires a PIN code to establish a connection, look for the code on the player or in its accompanying documentation. Refer to *Entering PIN code for Bluetooth wireless connection* on page 40.

### Disconnecting a Bluetooth audio player

● Touch DISCONNECT on the function menu.

After the disconnection is completed, NO CONNECTION is displayed.

### Displaying BD (Bluetooth Device) address

● Touch DEVICE INFO on the function menu to display the BD address.

Various information regarding the Bluetooth wireless technology are displayed.

- **DEVICE NAME** (device name of this system)
- **BD ADDRESS** (address of Bluetooth device)
- **SYSTEM VERSION** (system version)
- **BT MODULE VERSION** (version of Bluetooth module) 

## Bluetooth Telephone

### Basic Operations

- If you connect a Bluetooth adapter (e.g. CD BTB200) to this unit, you can control Bluetooth audio players via Bluetooth wireless technology.
- In some countries, CD BTB200 is not sold on the market.

### Important

- Since this unit is on standby to connect with your cellular phone via Bluetooth wireless technology, using this unit without running the engine can result in battery drainage.
- Advanced operations that require your attention such as dialing numbers on the monitor, using phone book, etc., are prohibited while you are driving. When you need to use these advanced operations, stop your vehicle in a safe place.

For details concerning operation, refer to the Bluetooth adapter's operation manual. This section provides brief information on the hands free phoning operations with this unit which slightly differs or is cut short from that described in the Bluetooth adapter's operation manual.

- This unit is not compatible with registration for guest phone.
- This unit does not have the name edit function of a Phone Book entry.

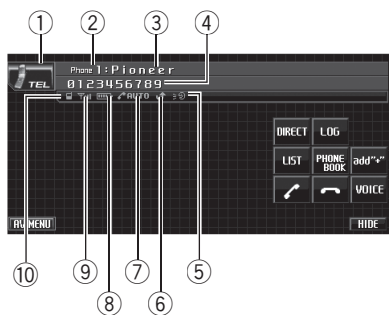

- ① Source icon

- ② User number indicator  
Shows the registration number of the cellular phone.
- ③ Device name  
Shows the device name of the cellular phone.
- ④ Phone number  
Shows the phone number you selected.
- ⑤ Voice recognition indicator  
Shows when the voice recognition function is on (for more details, refer to *Voice recognition* on the next page).
- ⑥ Incoming call notice indication  
Shows when an incoming call has been received and not checked yet.
- Incoming call notice is not displayed for calls made when your cellular phone is disconnected from this unit.
- ⑦ Automatic answering/Automatic rejecting indicator  
Shows when the automatic answering function is on (for more details, refer to *Setting automatic answering* on page 64).  
Shows when the automatic rejecting function is on (for more details, refer to *Setting automatic rejecting* on page 64).
- ⑧ Battery strength indicator  
Shows the battery strength of cellular phone.
- Battery strength indicator may differ from the actual battery strength.
  - If the battery strength is not available, nothing is displayed in the battery strength indicator area.
- ⑨ Signal level indicator  
Shows the signal strength of cellular phone.
- Signal level indicator may differ from the actual signal level.
  - Depending on the cellular phones featuring Bluetooth wireless technology, radio field intensity is not available. In this case, the signal level indicator does not appear.
  - If your cellular phone is out of service,  $\times$  is displayed.
- ⑩ Telephone indicator

## Available accessories

Shows when a phone connection using Blue tooth wireless technology is established (for more details, refer to *Connecting a cellular phone* on the next page).

- While connecting automatically, telephone indicator is flashing.

### ● Touch the source icon and then touch TEL to select the telephone.

#### Note

Equalizer curve for the phone source is fixed.

When selecting the phone source, you cannot operate the equalizer function. Refer to *Recalling equalizer curves* on page 32.

When the multi channel processor is connected to this unit, you can operate the equalizer function even when selecting the phone source. Refer to *Recalling equalizer curves* on page 77.

## Setting up for hands-free phoning

Before you can use the hands free phoning function you must set up the unit for use with your cellular phone. This entails establishing a Bluetooth wireless connection between this unit and your phone, registering your phone with this unit, and adjusting the volume level.

### 1 Connection

For detailed instructions on connecting your phone to this unit via Bluetooth wireless technology, refer to *Connecting a cellular phone* on the next page.

- Your phone should now be temporarily connected. However, to make best use of the technology, we recommend you register the phone to this unit.

### 2 Registration

To register your temporarily connected phone, refer to *Registering a connected cellular phone* on page 61.

### 3 Volume adjustment

Adjust the earpiece volume on your cellular phone for comfort. When adjusted, the volume

level is memorized in this unit as the default setting.

- Caller's voice volume and ring volume may vary depending on the type of cellular phone.
- If the difference between the ring volume and caller's voice volume is big, overall volume level may become unstable.
- Before disconnecting the cellular phone from this unit, make sure to adjust the volume to a proper level. If the volume is muted (zero level) on your cellular phone, the volume level of your cellular phone remains muted even after the cellular phone is disconnected.

## Making a phone call

### Voice recognition

#### 1 Touch VOICE to turn the voice recognition function on.

Voice dial icon appears on the information bar. Voice recognition function is now ready.

- To cancel the voice recognition function, touch VOICE again.

#### 2 Pronounce the name of your contact.

## Taking a phone call

### Answering an incoming call

#### 1 When a call comes in, touch .

- If private mode is selected on the cellular phone, hands free phoning may not be performed.

#### 2 To end the call, touch .

### Rejecting an incoming call

#### ● When a call comes in, touch .

The call is rejected.

### Answering a call waiting

#### 1 Touch to answer a call waiting.

## 2 Touch to end all calls.

- The caller you have been talking to is now on hold. To end the call, both you and your caller need to hang up the phone.
- While your callers hold the line, touching  switches between callers.

## Rejecting a call waiting

- Touch  to reject a call waiting.

## Introduction of advanced operations

### 1 Touch AV MENU and then touch FUNCTION MENU to display the function names.

The function names are displayed and operable ones are highlighted.

### 2 Touch ESC to return to the telephone standby display.

- To return to the previous display, touch **BACK**.

## Connecting a cellular phone

### Searching for available cellular phones

#### 1 Touch PHONE CONNECT on the function menu.

#### 2 Touch SEARCH to search for available cellular phones.

While searching, **SEARCHING** flashes. When available cellular phones featuring Bluetooth wireless technology are found, device name or **Name Not Found** (if names cannot be obtained) is displayed.

- If this unit fails to find any available cellular phones, **NOT FOUND** is displayed.
- You can display the BD address by touching **BD ADDR**. To return to the device name, touch **PHONE NAME**.

#### 3 Touch the device name you want to connect.

While connecting, **CONNECTING** flashes. To complete the connection, check the device

name (**Pioneer BT unit2**) and enter the link code on your cellular phone. If the connection is established, **CONNECTED** is displayed.

- PIN code is set to **0000** as default. You can change this code in the initial setting. Refer to *Entering PIN code for Bluetooth wireless connection* on page 40.

## Using a cellular phone to initiate a connection

### 1 Touch PHONE CONNECT on the function menu.

### 2 Touch CONNECTION OPEN.

**CONNECTION WAITING** flashes and the unit is now on standby for connection from a cellular phone.

### 3 Use cellular phone to connect to this unit.

- To cancel this function, touch **CONNECTION OPEN** again.
- PIN code is set to **0000** as default. You can change this code in the initial setting. Refer to *Entering PIN code for Bluetooth wireless connection* on page 40.

## Disconnecting a cellular phone

### 1 Touch PHONE CONNECT on the function menu.

### 2 Touch DISCONNECT to disconnect the currently connected cellular phone from this unit.

After disconnection is completed, **NO CONNECTION** is displayed.

## Available accessories

### Registering a connected cellular phone

#### 1 Touch PHONE REGISTER on the function menu.

Registration assignments for user phone 1, 2 and 3 appear on the display.

#### 2 Touch and hold one of the registration assignments to register the currently connected phone.

If the registration is succeeded, the device name of the connected phone is displayed in the selected assignment.

- If the assignment is empty, the device name is not displayed. If the assignment is already taken, the device name appears. To replace an assignment with a new phone, first delete the current assignment. For more detailed instructions, see *Deleting a registered phone* on this page.

- If the registration failed, device name of the connected phone is not displayed in the selected assignment. In this case, return to step 1 and try again.

### Deleting a registered phone

#### 1 Touch PHONE REGISTER on the function menu.

#### 2 Touch DELETE next to the device name you want to delete.

A confirmation display appears. Touch **OK** to delete the phone.

- To cancel deleting a registered phone, touch **CANCEL**.

### Connecting to a registered cellular phone

#### Connecting to a registered phone manually

#### 1 Touch PHONE CONNECT on the function menu.

#### 2 Touch DIRECT CONNECT.

#### 3 Touch the device name you want to connect.

While connecting, **CONNECTING** is flashing. If the connection is established, **CONNECTED** is displayed.

#### Connecting to a registered phone automatically

#### 1 Touch NEXT on the function menu.

#### 2 Touch AUTO CONNECT to turn the Automatic Connection function on.

If your cellular phone is ready for Bluetooth wireless connection, connection to this unit is automatically established.

- To turn automatic connection off, touch **AUTO CONNECT** again.

### Using the phone book

#### Transferring entries to the phone book

The Phone Book can hold a total of 500 entries. 300 from User 1, 150 from User 2, and 50 from User 3.

#### 1 Touch PHONE BOOK TRANSFER on the function menu.

#### 2 Touch START to turn the Phone Book Transfer function on.

The Phone Book Transfer is now on standby.

#### 3 Use the cellular phone to perform phone book transfer.

Perform phone book transfer using the cellular phone. For detailed instructions, refer to the instruction manual that came with your cellular phone.

- The display indicates how many entries have been transferred and the total number to be transferred.

- To cancel the transferring process, touch **STOP**.

#### 4 When you are done transferring Phone Book entries, touch ESC.

**Note**

When the phone book transfer is complete, the connection to your cellular phone is off. To use the Phone Book, connect to your cellular phone once again, referring to *Connecting to a registered cellular phone* on the previous page.

**Changing the phone book display order**

- **Touch PHONE BOOK NAME VIEW on the function menu to change the name view order.**

**INVERTED** is displayed and the name view order is changed.

- To change to the original order (**ORIGINAL**), touch **PHONE BOOK NAME VIEW** again.

**Calling a number in the phone book****Important**

Be sure to park your vehicle and apply the parking brake when performing this operation.

- 1 Touch PHONE BOOK to display the Phone Book.**
- 2 Touch ▲ or ▼ to select the first letter of the name you are looking for.**  
Touching ▲ or ▼ changes alphabetical letters.
- 3 Touch ENTER to show entries starting with the letter you chose.**  
The display shows the first six Phone Book entries starting with that letter (e.g. "Ben", "Brian" and "Burt" when "B" is selected).
  - Touch ⤴ or ⤵ to display other phone book entries.
  - To refine the search with a different letter, touch **CLEAR**.
- 4 Touch a Phone Book entry you want to call.**

The display is switched to the Phone Book detail display.

**5 Touch phone number of the Phone Book entry you want to call.**

If several phone numbers are entered to an entry, touch one you want to call. The display returns to the normal display and the Phone Book entry you selected is displayed on the information bar.

**6 Touch ↗ to make a call.**

- For an international call, touch **add "+"** to add + to the phone number.

**7 To end the call, touch ↶.****Editing phone numbers****Important**

Be sure to park your vehicle and apply the parking brake when performing this operation.

You can edit the numbers of Phone Book entries. Each phone number can be up to 24 digits long.

- 1 Touch PHONE BOOK to display the Phone Book.**
- 2 Select a Phone Book entry you want to edit.**  
See step two to four on *Calling a number in the phone book* on this page for how to do this.
- 3 Touch EDIT next to the phone number you want to edit.**  
The display is changed to the Phone Book dial edit display.
- 4 Touch 0 to 9 to input numbers.**
  - For an international call, touch **add "+"** to add + to the phone number.
  - Touch **CLEAR** to delete the number. Touch and hold **CLEAR** to delete all the input numbers.
- 5 Touch OK to store the new number.**

## Available accessories

### Clearing a phone book entry



#### Important

Be sure to park your vehicle and apply the park brake when performing this operation.

#### 1 Touch **PHONE BOOK** to display the Phone Book.

#### 2 Select a Phone Book entry you want to delete.

See step two to four on *Calling a number in the phone book* on the previous page for how to do this.

#### 3 Touch **DELETE** to delete the Phone Book entry.

A confirmation display appears. Touch **YES** to delete the entry.

- If you do not want to clear a Phone Book entry that you have selected, touch **NO**.

### Using the call history



#### Important

Be sure to park your vehicle and apply the park brake when performing this operation.

The 6 most recent calls made (dialled), received and missed, are stored in the Call History. You can browse the Call History and call numbers from it.

#### 1 Touch **LOG** to display the Call History.

Touching **LOG** repeatedly switches between the following call histories:

**MISSED CALL LIST** (missed call)

**DIALED CALL LIST** (dialled call)

**RECEIVED CALL LIST** (received call)

- You can switch between phone number and name (if entered) by touching **ABC/123**.
- If no phone numbers have been stored in the selected list, nothing is displayed.

#### 2 Touch a phone number or name (if entered) you want to call.

The display returns to the normal display and the phone number you selected is displayed on the information bar.

#### 3 Touch **↗** to make a call.

- For an international call, touch **add "+"** to add + to the phone number.

#### 4 To end the call, touch **↵**.

### Using preset numbers



#### Important

Be sure to park your vehicle and apply the park ing brake when performing this operation.

#### Assigning preset numbers

Numbers that you dial frequently can be as signed to presets for quick recall.

You can assign up to 6 frequently called phone numbers to number presets.

#### 1 Select a desired phone number from the phone book or the call history. Or directly enter a desired phone number.

To select a desired phone number from the Phone Book or the Call History, see the instructions explained in previous pages. To directly enter a desired phone number, see *Making a call by entering phone number* on the next page.

The display should now be the normal display and the selected phone number is displayed on the information bar.

#### 2 Touch **LIST** to display preset assignments.

Preset assignments appear in the display (if not displayed yet).

#### 3 Keep touching one of preset assignments to store the phone number.

The phone number you selected is stored in presets.

## Available accessories

- **No Data** is displayed for empty assignment. Even if the assignment is taken, you can replace it to the new one by keeping touching the assignment.

### Recalling preset numbers

#### 1 Touch LIST to display preset assignments.

Preset assignments appear in the display (if not displayed yet).

#### 2 Touch one of preset assignments.

The selected phone number should now be displayed on the information bar.

#### 3 Touch to make a call.

#### 4 To end the call, touch .

### Making a call by entering phone number

#### Important

Be sure to park your vehicle and apply the parking brake when performing this operation.

#### 1 Touch DIRECT to display the direct dial display.

#### 2 Touch 0 to 9 to input numbers.

- For an international call, touch **add "+"** to add + to the phone number.
- Touch **CLEAR** to delete the number. Touch and hold **CLEAR** to delete all the input numbers.
- Up to 24 digits can be entered.
- If you want to store the entered phone number to preset assignment, touch **SET** here. The display returns to the normal display and the phone number you entered is selected.

#### 3 When you completed entering the number, touch to make a call.

#### 4 To end the call, touch .

### Clearing memory

#### 1 Touch CLEAR MEMORY on the function menu.

#### 2 Touch CLEAR next to the item you want to delete from the memory.

Select from the following:

- **PHONE BOOK** (phone book)
- **DIALED CALLS** (dialled call history)
- **RECEIVED CALLS** (received call history)
- **MISSED CALLS** (missed call history)
- **DIAL PRESET** (preset phone numbers)

After selecting a desired item, a confirmation display appears. Touch **OK** to delete the memory.

- If you do not want to clear memory that you have selected, touch **CANCEL**.
- If you want to clear all the Phone Book, dialled/received/missed call history list and preset phone number, touch **CLEAR ALL**.

### Setting automatic answering

#### ● Touch AUTO ANSWER on the function menu to turn the automatic answer on.

- To turn the automatic answer off, touch **AUTO ANSWER** again.

### Setting automatic rejecting

#### 1 Touch NEXT on the function menu.

#### 2 Touch REFUSE ALL CALLS to turn the automatic call rejection on.

- To turn the automatic call rejection off, touch **REFUSE ALL CALLS** again.

### Switching the ring tone

#### 1 Touch NEXT on the function menu.

#### 2 Touch RING TONE to turn the ring tone on.

- To turn the ring tone off, touch **RING TONE** again.



## Available accessories

### Echo canceling and noise reduction

- 1 Touch **NEXT** on the function menu.
- 2 Touch **ECHO CANCEL** to turn Echo Cancel function on.
  - To turn echo canceling off, touch **ECHO CANCEL** again.

### Displaying BD (Bluetooth Device) address

#### Displaying BD address of this system

- 1 Touch **NEXT** on the function menu.
- 2 Touch **DEVICE INFO** to display the BD address.

Various information regarding the Bluetooth wireless technology are displayed.

- **DEVICE NAME** (device name of this system)
- **BD ADDRESS** (address of Bluetooth device)
- **SYSTEM VERSION** (version of this unit's microprocessor)
- **BT MODULE VERSION** (version of Bluetooth module)

#### Displaying BD address of your cellular phone

- 1 Touch **PHONE CONNECT** on the function menu.
- 2 Touch **BD ADDRESS** to display the BD address.  
12 digit hexadecimal string is displayed.
  - To return to the device name, touch **PHONE NAME**. 

### Multi-CD Player

#### Basic Operations

You can use this unit to control a multi CD player, which is sold separately.

- This unit does not have **ITS** playlist, disc title and track title list functions.
- Only functions described in this manual are supported by 50 disc multi CD players.
- This unit is not designed to operate disc title list functions with a 50 disc multi CD player.

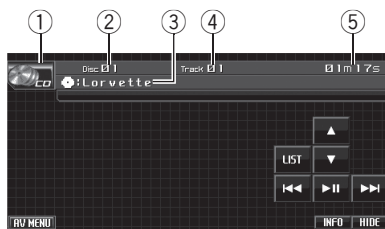

- ① Source icon
- ② Disc number indicator
- ③ Disc title indicator  
Shows the title of the currently playing disc only when playing CD TEXT discs.
- ④ Track number indicator
- ⑤ Play time indicator

- 1 Touch the source icon and then touch **MCD** to select the multi-CD player.
- 2 Touch **▲** or **▼** to select a disc.
- 3 To skip back or forward to another track, briefly touch **◀◀** or **▶▶**.
- 4 To perform fast forward or reverse, keep touching **◀◀** or **▶▶**.



#### Notes

- When multi CD player completes preparatory operations, **READY** is displayed.
- If an error message such as **ERROR-02-XX** is displayed, refer to the multi CD player owner's manual.
- If there are no discs in the multi CD player magazine, **NO DISC** is displayed.

## Selecting a disc

- 1 Touch **LIST**.
- 2 Touch your favorite disc.  
Selectable discs are highlighted.
- 3 Touch **ESC** to return to the ordinary display.

## Pausing CD playback

- Touch **▶II** during playback.
  - To resume playback at the same point that you turned pause on, touch **▶II** again.

## Introduction of advanced operations

You can only use these functions with a multi CD player that supports them.

- 1 Touch **AV MENU** and then touch **FUNCTION MENU** to display the function names.

The function names are displayed and operable ones are highlighted.

- 2 Touch **ESC** to return to the playback display.
  - To return to the previous display, touch **BACK**.

## Function and operation

**REPEAT**, **RANDOM**, **SCAN** and **COMPRESSION** operations are basically the same as that of the built in DVD player.

Function name	Operation
<b>REPEAT</b>	Refer to <i>Repeating play</i> on page 26. However, the repeat play ranges you can select are different from that of the built in DVD player. The repeat play ranges of the multi CD player are: <ul style="list-style-type: none"> <li>• <b>MULTI-CD</b> Repeat all discs in the multi CD player</li> <li>• <b>TRACK</b> Repeat just the current track</li> <li>• <b>DISC</b> Repeat the current disc</li> </ul>
<b>RANDOM</b>	Refer to <i>Playing tracks in random order</i> on page 26.
<b>SCAN</b>	Refer to <i>Scanning tracks or folders</i> on page 26.
<b>COMPRESSION</b>	Refer to <i>Using compression</i> on page 27. Multi CD player has COMP (compression) and DBE (dynamic bass emphasis) functions. The settings can be switched as below: <b>OFF COMP1 COMP2 OFF</b> <b>DBE 1 DBE 2</b>



### Notes

- If you select other discs during repeat play, the repeat play range changes to **MULTI-CD**.
- If you perform track search or fast forward/reverse during **TRACK**, the repeat play range changes to **DISC**.
- After track or disc scanning is finished, normal playback of the tracks begins again.
- If the multi CD player does not support COMP/DBE, you cannot operate this function.

## Using CD TEXT functions

You can use these functions only with a CD TEXT compatible multi CD player.

The operation is the same as that of the built in DVD player.

Refer to *Text information* on page 25. ▣

## Available accessories

### DVD Player

#### Basic Operations

You can use this unit to control a DVD player or multi DVD player, which is sold separately.

For details concerning operation, refer to the DVD player's or multi DVD player's operation manual. This section provides information on DVD operations with this unit which differs from that described in the DVD player's or multi DVD player's operation manual.

- This unit does not have ITS playlist and disc title functions.

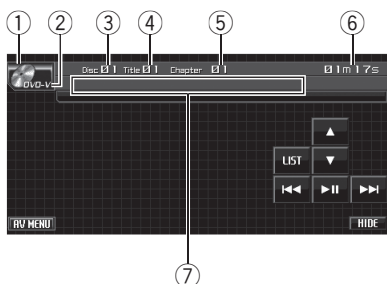

- ① Source icon
- ② Media indicator
- ③ Disc number indicator  
Shows the number of the disc currently playing when using a multi DVD player.
- ④ Title/Folder number indicator
- ⑤ Chapter/track number indicator
- ⑥ Play time indicator
- ⑦ Variable message area  
Shows the text information of disc currently playing when playing a compressed audio disc.
  - This unit cannot display the text information recorded on a CD TEXT disc playing on the optional DVD player.

#### 1 Touch the source icon and then touch S-DVD to select the DVD player.

- When the source icon is not displayed, you can display it by touching the screen.

#### 2 Touch the screen to display the touch panel keys.

3 To skip back or forward to another chapter/track, briefly touch ◀◀ or ▶▶.

4 To perform fast forward or reverse, keep touching ◀◀ or ▶▶.

#### Note

If you do not use the touch panel keys within 30 seconds, they will be hidden automatically when playing DVD video or Video CD.

### Selecting a disc

- You can operate this function only when a multi DVD player is connected to this unit.

#### 1 Touch LIST.

#### 2 Touch your favorite disc.

Selectable discs are highlighted.

3 Touch ESC to return to the ordinary display.

#### Note

You can also select a disc by keeping touching ▲ or ▼.

### Selecting a folder

- You can operate this function only when a DVD player compatible with compressed audio playback is connected to this unit.

- Touch ▲ or ▼ to select a folder.

### Pausing disc playback

- Touch ▶II during playback.
  - To resume playback at the same point that you turned pause on, touch ▶II again.

## Introduction of advanced operations

### 1 Touch AV MENU and then touch FUNCTION MENU to display the function names.

The function names are displayed and operable ones are highlighted.

### 2 Touch ESC to return to the playback display.

- To return to the previous display, touch **BACK**.

## Function and operation

**REPEAT**, **RANDOM** and **SCAN** operations are basically the same as that of the built in DVD player.

Function name	Operation
<b>REPEAT</b>	<p>Refer to <i>Repeating play</i> on page 26. But the repeat play range that you can select is vary depending on the type of disc or system. The repeat play ranges of the DVD player/multi DVD player are as below: During PBC playback of Video CDs, this function cannot be operated.</p> <ul style="list-style-type: none"> <li>• <b>DISC</b> Repeat the current disc</li> <li>• <b>FOLDER</b> Repeat the current folder</li> <li>• <b>TITLE</b> Repeat just the current title</li> <li>• <b>CHAPTER</b> Repeat just the current chapter</li> <li>• <b>TRACK</b> Repeat the current track</li> </ul>
<b>RANDOM</b>	Refer to <i>Playing tracks in random order</i> on page 26.
<b>SCAN</b>	Refer to <i>Scanning tracks or folders</i> on page 26.

## Notes

- If you select other discs during repeat play, the repeat play range changes to **DISC**.
- When playing back Video CD or CD, if you perform track search or fast forward/reverse dur

ing **TRACK**, the repeat play range changes to **DISC**.

- When playing back compressed audio, if you select another folder during repeat play, the repeat play range changes to **DISC**.
- When playing back compressed audio, if you perform track search or fast forward/reverse during **TRACK**, the repeat play range changes to **FOLDER**.

## Displaying text information of an audio file

The operation is the same as that of the built in DVD player.

Refer to *Text information* on page 25.

- If the characters recorded on the audio file are not compatible with this unit, those characters will not be displayed.

## Selecting files from the file name list

- You can operate this function only when a DVD player compatible with compressed audio playback is connected to this unit.

### 1 Touch LIST to display the disc list.

### 2 Touch LIST repeatedly to switch the lists.

**DISC LIST** (disc list) **FOLDER&FILE LIST** (folder and file list)

### 3 Select the desired file name (or folder name).

The operation is the same as that of the built in DVD player.

Refer to *Selecting files from the file name list* on page 25. 

## Available accessories

### TV tuner

#### Basic Operations

You can use this unit to control a TV tuner (e.g. GEX P5700TV), which is sold separately.

For details concerning operation, refer to the TV tuner's operation manual. This section provides information on TV operations with this unit, which differs from that described in the TV tuner's operation manual.

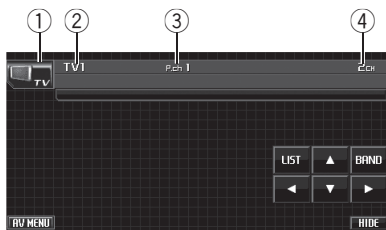

- ① Source icon
- ② Band indicator
- ③ Preset number indicator
- ④ Channel indicator

#### 1 Touch the source icon and then touch TV to select the TV.

- When the source icon is not displayed, you can display it by touching the screen.

#### 2 Touch the screen to display the touch panel keys.

#### 3 Touch BAND to select a band.

Touch **BAND** repeatedly until the desired band is displayed, **TV1** or **TV2**.

#### 4 To perform manual tuning, briefly touch ◀ or ▶.

#### 5 To perform seek tuning, keep touching ◀ or ▶ for about one second and release.

The tuner will scan the channels until a broadcast strong enough for good reception is found.

- You can cancel seek tuning by briefly touching either ◀ or ▶.

- If you keep touching ◀ or ▶ you can skip broadcasting channels. Seek tuning starts as soon as you release the keys.

#### Note

If you do not use the touch panel keys within 30 seconds, they will be hidden automatically.

### Storing and recalling broadcast stations

If you touch any of the preset tuning keys **P01** to **P12** you can easily store up to 12 broadcast stations for later recall with the touch of a key.

- Up to 24 stations, 12 for each of two TV bands, can be stored in memory.

#### 1 Touch LIST to display the preset list.

- When the touch panel keys are not displayed, you can display them by touching the screen.

#### 2 When you find a station that you want to store in memory, keep touching one of preset tuning keys P01 to P12 until the beep sounds.

The next time you touch the same preset tuning key the station is recalled from memory.

- To switch between **P01** to **P06** and **P07** to **P12**, touch **PREV** or **NEXT**.

#### 3 Touch ESC to return to the ordinary display.

#### Note

You can also use ▲ and ▼ to recall stations assigned to preset tuning keys **P01** to **P12**.

### Storing the strongest broadcast stations sequentially

1 Touch **AV MENU** and then touch **FUNCTION MENU** to display the function names.

## 2 Touch BSSM on the function menu to turn BSSM on.

**BSSM** begins to flash. While **BSSM** is flashing the 12 strongest broadcast stations will be stored in order from the lowest channel up. When finished, **BSSM** stops flashing.

- To cancel the storage process, touch **BSSM** again.

## 3 Touch ESC to return to the TV picture.

- To return to the previous display, touch **BACK**.



### Note

Storing broadcast stations with BSSM may replace broadcast stations you have saved using **P01** to **P12**. ■

## Digital Signal Processor

### Introduction of DSP adjustments

You can use this unit to control multi channel processor (e.g. DEQ P8000), which is sold separately.

- Some functions may differ depending on the multi channel processor connected to this unit.



### Important

When a multi channel processor and an optional DVD player are connected to this unit, be sure to use an optical cable (e.g., CD AD600).

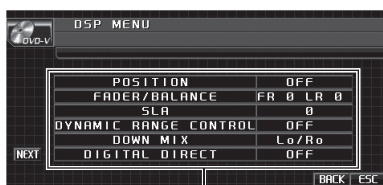

①

#### ① DSP display

Shows the DSP function names.

By carrying out the following settings/adjustments in the order shown, you can create a finely tuned sound field effortlessly.

- Setting the speaker setting
- Using the position selector
- Auto TA and EQ (auto time alignment and auto equalizing)
- Adjusting the time alignment
- Adjusting the speaker output levels using a test tone
- Selecting a cross over frequency
- Adjusting the speaker output levels
- Adjusting 3 band parametric equalizer

### 1 Touch AV MENU and then touch DSP MENU to display the DSP function names.

The DSP function names are displayed and operable ones are highlighted.

## Available accessories

- To go to the next group of function names, touch **NEXT**.
- To return to the previous group of function names, touch **PREV**.
- When playing discs recorded with more than 96 kHz sampling frequency, you cannot use audio functions. Also, equalizer curve setting, **POSITION**, **AUTO EQ** and **AUTO TA** will be cancelled.
- When playing discs recorded with more than 96 kHz sampling frequency, audio is outputted from front speakers only.
- When selecting FM as the source, you cannot switch to **SLA**.
- When playing other than the DVD disc, you cannot switch to **DYNAMIC RANGE CONTROL**.
- When neither **FRONT-L** nor **FRONT-R** is selected in **POSITION**, you cannot switch to **TIME ALIGNMENT**.
- When both the center speaker and the rear speaker are set to OFF in the speaker setting, you cannot switch to **DOLBY PRO LOGIC II**.

### 2 Touch ESC to return to the ordinary display.

- To return to the previous display, touch **BACK**.

## Using the sound field control

The SFC function creates the sensation of a live performance.

- The acoustics of different performance environments are not the same and depend on the extent and contour of space through which sound waves move and on how sounds bounce off the stage, walls, floors and ceilings. At a live performance you hear music in three stages: direct sound, early reflections, and late reflections, or reverberations. Those factors are programmed into the SFC circuitry to recreate the acoustics of various performance settings.

### 1 Press EQ and hold to switch to SFC function.

- To switch to equalizer function, press **EQ** and hold again.

### 2 Press EQ to select the desired SFC mode.

**MUSICAL** (musical) **DRAMA** (drama)  
**ACTION** (action) **JAZZ** (jazz) **HALL** (hall)  
**CLUB** (club) **OFF** (off)



#### Note

If the source is a 2 channel LPCM audio or a 2 channel Dolby Digital audio and you select SFC effects that are most applicable for 5.1 channel audio (i.e., **MUSICAL**, **DRAMA** or **ACTION**), we recommend turning Dolby Pro Logic II on. On the other hand, when selecting SFC effects that are intended for use with 2 channel audio (i.e., **JAZZ**, **HALL** or **CLUB**), we recommend turning Dolby Pro Logic II off.

## Using the position selector

One way to assure a more natural sound is to accurately position the stereo image, putting you right in the center of the sound field. The position selector function lets you automatically adjust the speaker output levels and inserts a delay time to match the number and position of occupied seats. When used in conjunction with the SFC, the feature will make the sound image more natural and offer a panoramic sound that envelops you.

### 1 Touch POSITION on the DSP function menu.

### 2 Touch ◀▶/▲/▼ to select a listening position.

Touch one of these, ◀▶/▲/▼, to select a listening position as listed in the table.

Key	Display	Position
◀	FRONT-L	Front seat left
▶	FRONT-R	Front seat right
▲	FRONT	Front seats
▼	ALL	All seats

- To cancel the selected listening position, touch the same key again.

**Note**

When you make adjustments to the listening position, the speaker outputs are automatically set for appropriate levels. You can tailor the levels more precisely referring to *Adjusting the speaker output levels using a test tone* or *Adjusting the speaker output levels*.

**Using balance adjustment**

You can change the fader/balance setting so that it can provide the ideal listening environment in all occupied seats.

**1 Touch FADER/BALANCE on the DSP function menu.****2 Touch ▲ or ▼ to adjust front/rear speaker balance.**

Each time you touch ▲ or ▼ it moves the front/rear speaker balance towards the front or the rear.

**FRONT:25** to **REAR:25** is displayed as the front/rear speaker balance moves from front to rear.

- **FR: 0** is the proper setting when only two speakers are used.

**3 Touch ◀ or ▶ to adjust left/right speaker balance.**

Each time you touch ◀ or ▶ it moves the left/right speaker balance towards the left or the right.

**LEFT:25** to **RIGHT:25** is displayed as the left/right speaker balance moves from left to right.

**Adjusting source levels**

SLA (source level adjustment) lets you adjust the volume level of each source to prevent radical changes in volume when switching between sources.

- Settings are based on the FM volume level, which remains unchanged.

**1 Compare the FM volume level with the level of the source you wish to adjust.****2 Touch SLA on the DSP function menu.****3 Touch ◀ or ▶ to adjust the source volume.**

Each time you touch ◀ or ▶ it increases or decreases the source volume.

**+4** to **-4** is displayed as the source volume is increased or decreased.

**Notes**

- The AM volume level can also be adjusted with source level adjustments.
- Video CD, CD, compressed audio and DivX are set to the same source level adjustment volume automatically.
- DVD and the optional DVD player are set to the same source level adjustment volume automatically.
- External unit 1 and external unit 2 are set to the same source level adjustment volume automatically.
- AUX (auxiliary input) and AV (AV input) are set to the same source level adjustment volume automatically.

**Using the dynamic range control**

The dynamic range refers to the difference between the largest and softest sounds. The dynamic range control compresses this difference so that you can clearly hear sounds even at low volume levels.

- The dynamic range control is effective only on Dolby Digital sounds.
- When playing other than the DVD disc, you cannot switch to **DYNAMIC RANGE CONTROL**.

**1 Touch DYNAMIC RANGE CONTROL on the DSP function menu.****2 Touch ▶ to turn the dynamic range control on.**

- To turn dynamic range control off, touch ◀.



## Available accessories

### Using the down-mix function

The down mix function allows you to play back multi channel audio in 2 channels.

- 1 **Touch DOWN MIX on the DSP function menu.**
- 2 **Touch ◀ or ▶ to select the desired level.**
  - **Lo/Ro** Stereo mix the original audio that do not contain channel modes such as surround components.
  - **Lt/Rt** Down mix so that the surround components can be restored (decoded).

### Using the direct control

You can override audio settings to check for effectiveness of your audio settings.

- All audio functions are locked out when the direct control is on except **VOLUME/MUTE** and **DOLBY PRO LOGIC II**.
- 1 **Touch DIGITAL DIRECT on the DSP function menu.**
  - 2 **Touch ▶ to turn the direct control on.**
    - To turn direct control off, touch ◀.

### Using the Dolby Pro Logic II

Dolby Pro Logic II creates five full bandwidth output channels from two channel sources to achieve high purity matrix surround.

- Dolby Pro Logic II supports up to 48kHz sampling rate stereo source and has no effect on other types of source.
- When both the center speaker and the rear speaker are set to OFF in the speaker setting, you cannot switch to **DOLBY PRO LOGIC II**.

- 1 **Touch NEXT on the DSP function menu.**
- 2 **Touch DOLBY PRO LOGIC II.**
- 3 **Touch any of the following touch panel keys to select the desired mode.**
  - **MOVIE** The Movie mode suitable for movie playback

- **MUSIC** The Music mode suitable for music playback
- **MATRIX** The Matrix mode for when FM radio reception is weak
- **OFF** Turn Dolby Pro Logic II off
- **MUSIC ADJUST** Adjust the Music mode
  - You can operate **MUSIC ADJUST** only when **MUSIC** has been selected.

### Adjusting the Music mode

You can adjust the Music mode with the following three controls.

- Panorama (**PANORAMA**) extends the front stereo image to include the surround speakers for an exciting “wraparound” effect.
- Dimension (**DIMENSION**) allows you to gradually adjust the sound field either towards the front or the rear.
- Center Width Control (**CENTER WIDTH**) allows center channel sounds to be positioned between the center speaker and the left/right speakers. It improves the left center right stage presentation for both the driver and the front passenger.

- 1 **Touch NEXT on the DSP function menu.**
- 2 **Touch DOLBY PRO LOGIC II.**
- 3 **Touch MUSIC and then touch MUSIC ADJUST.**
  - You can operate **MUSIC ADJUST** only when **MUSIC** has been selected.

- 4 **Touch ▲ or ▼ to select PANORAMA (panorama).**

Each time you touch ▲ or ▼ selects the item in the following order:

**PANORAMA** (panorama) **DIMENSION** (dimension) **CENTER WIDTH** (center width)

- 5 **Touch ▶ to turn the panorama control on.**
  - To turn the panorama control off, touch ◀.

## Available accessories

### 6 Touch ▼ to select DIMENSION and then touch ◀ or ▶ to adjust front/surround speaker balance.

Each time you touch ◀ or ▶ it moves the sound towards the front or the surrounds. +3 to -3 is displayed as the front/surround speaker balance moves from front to surrounds.

### 7 Touch ▼ to select CENTER WIDTH and then touch ◀ or ▶ to adjust the center image.

Each time you touch ◀ or ▶ it gradually spreads the center channel sound into the front left and right speakers over a range 0 to 7.

3 is the default and it's recommended for most recordings. 0 places all center sound in the center speaker. 7 places all center sound equally in the left/right speakers.

## Setting the speaker setting

You need to make with/without (or yes/no) and size (bass reproducing capacity) selection/adjustments depending on the installed speakers. The size needs to be set to **LARGE** (large) if the speaker is capable of reproducing sounds of about 100 Hz or below. Otherwise select **SMALL** (small).

- Low frequency range is not output if the subwoofer is set to **OFF** and the front and rear speakers set to **SMALL** or **OFF**.
- It is imperative that non installed speakers be set to **OFF**.
- Set the front or rear speaker to **LARGE** if the speaker is capable of reproducing bass content, or if no subwoofer is installed.

#### 1 Touch NEXT on the DSP function menu.

#### 2 Touch SPEAKER SETTING.

#### 3 Touch ▲ or ▼ to select the speaker to be adjusted.

Each time you touch ▲ or ▼ selects the speaker in the following order:

**FRONT** (front speakers) **CENTER** (center speaker) **REAR** (rear speakers)

**SUB WOOFER** (subwoofer) **PHASE** (subwoofer setting)

- You can switch to **PHASE** only when the subwoofer has been set to **ON**.

#### 4 Touch ◀ or ▶ to select the correct size for the selected speaker.

Each time you touch ◀ or ▶ selects the size in the following order:

**OFF** (off) **SMALL** (small) **LARGE** (large)

- You cannot select **OFF**, when **FRONT** (front speakers) have been selected.
- You can select **ON** or **OFF**, when **SUB WOOFER** (subwoofer) has been selected.
- You can switch **REVERSE** (reverse phase) or **NORMAL** (normal phase), when **PHASE** (subwoofer setting) has been selected.

## Correcting the subwoofer's phase

If trying to boost the bass output of the subwoofer doesn't do much or rather makes you feel that the bass gets more murky, this may indicate that the subwoofer's output and bass content you hear over other speakers cancel each other out. To remove this problem, try changing the phase setting for the subwoofer.

#### 1 Touch NEXT on the DSP function menu.

#### 2 Touch SPEAKER SETTING.

#### 3 Touch ▲ or ▼ to select SUB WOOFER (subwoofer).

Each time you touch ▲ or ▼ selects the speaker in the following order:

**FRONT** (front speakers) **CENTER** (center speaker) **REAR** (rear speakers)

**SUB WOOFER** (subwoofer) **PHASE** (subwoofer setting)

#### 4 Touch ▶ to turn subwoofer output on.

- To turn subwoofer output off, touch ◀.

#### 5 Touch ▼ and then touch ◀ or ▶ to select the phase of subwoofer output.

Touch ▶ to select normal phase and **NORMAL** appears in the display. Touch ◀ to select reverse phase and **REVERSE** appears in the display.

## Available accessories

### Note

When playing a 2 channel mono source with Pro Logic turned on, there may be occasions when the following will occur:

- No audio is outputted if the center speaker setting is **SMALL** or **LARGE** and no center speaker is installed.
- Audio is heard only over the center speaker if installed and the center speaker setting is **SMALL** or **LARGE**.

## Adjusting the speaker output levels

Speaker level can be adjusted finely by listening to an audio output. First, use test tone to adjust the approximate speaker level, and then use this function to adjust finely.

**1 Touch NEXT on the DSP function menu.**

**2 Touch SPEAKER LEVEL.**

**3 Touch ▲ or ▼ to select the speaker to be adjusted.**

Each time you touch ▲ or ▼ selects the speaker in the following order:

**FRONT L** (front speaker left) **CENTER** (center speaker) **FRONT R** (front speaker right)  
**REAR R** (rear speaker right) **REAR L** (rear speaker left) **SUB WOOFER** (subwoofer)

- You cannot select speakers whose size is set at **OFF**. (Refer to *Setting the speaker setting* on the previous page.)

**4 Touch ◀ or ▶ to adjust the speaker output level.**

Each time you touch ◀ or ▶ increases or decreases the speaker output level. **+10** to **-10** is displayed as the level is increased or decreased.

### Note

To adjust the speaker output levels in this mode is the same as making the speaker output levels at **TEST TONE**. Both provide the same results.

## Selecting a cross-over frequency

You can select a frequency, under which sounds are reproduced through the subwoofer. If the installed speakers include one whose size has been set to **SMALL**, you can select a frequency, under which sounds are reproduced through a **LARGE** speaker or subwoofer.

**1 Touch NEXT on the DSP function menu.**

**2 Touch CROSS OVER.**

**3 Touch ▲ or ▼ to select the speaker to be adjusted.**

Each time you touch ▲ or ▼ selects the speaker in the following order:

**FRONT** (front speakers) **CENTER** (center speaker) **REAR** (rear speakers)  
**SUB WOOFER** (subwoofer)

**4 Touch ◀ or ▶ to select cross-over frequency.**

Each time you touch ◀ or ▶ selects cross over frequencies in the following order:

**63Hz 80Hz 100Hz 125Hz 160Hz 200Hz**

### Note

Selecting a cross over frequency is to set a cross over frequency of the subwoofer's L.P.F. (low pass filter) and that of the **SMALL** speaker H.P.F. (high pass filter). The cross over frequency setting has no effect if the subwoofer is set to **OFF** and other speakers are set to **LARGE** or **OFF**.

## Adjusting the speaker output levels using a test tone

This function allows you to easily get the overall balance right among the speakers.

**1 Touch NEXT on the DSP function menu.**

**2 Touch TEST TONE.**

### 3 Touch START to start the test tone output.

The test tone is outputted. It rotates from speaker to speaker in the following sequence at intervals of about two seconds. The current settings for the speaker over which you hear the test tone are shown in the display.

**FRONT L** (front speaker left) **CENTER** (center speaker) **FRONT R** (front speaker right)

**REAR R** (rear speaker right) **REAR L** (rear speaker left) **SUB WOOFER** (subwoofer)

Check each speaker output level. If no adjustments are needed, perform step 5 to stop the test tone.

- The settings do not appear for speakers whose size is set **OFF**. (Refer to *Setting the speaker setting* on page 74.)

### 4 Touch ◀ or ▶ to adjust the speaker output level.

Each time you touch ◀ or ▶ increases or decreases the speaker output level. **+10** to **-10** is displayed as the level is increased or decreased.

- The test tone rotates to the next speaker after about two seconds from the last operation.

### 5 Touch STOP to stop the test tone output.



#### Notes

- If needed, select speakers and adjust their 'absolute' output levels. (Refer to *Adjusting the speaker output levels* on the previous page.)
- To adjust the speaker output levels in this mode is the same as making the speaker output levels at **SPEAKER LEVEL**. Both provide the same results.

## Using the time alignment

The time alignment lets you adjust the distance between each speaker and the listening position.

### 1 Touch NEXT on the DSP function menu.

### 2 Touch TIME ALIGNMENT.

### 3 Touch any of the following touch panel keys to select the time alignment.

- **INITIAL** Initial time alignment (factory setting)
- **AUTO TA** Time alignment created by auto TA and EQ. (Refer to *Auto TA and EQ (auto time alignment and auto equalizing)* on page 78.)
- **CUSTOM** Adjusted time alignment that you can create for yourself
- **OFF** Turn the time alignment off
- **ADJUSTMENT** Adjust the time alignment as desired
  - You cannot select **AUTO TA** if auto TA and EQ has not been carried out.
  - You cannot select **ADJUSTMENT** when neither **FRONT-L** nor **FRONT-R** is selected in **POSITION**.

## Adjusting the time alignment

You can adjust the distance between each speaker and the selected position.

- An adjusted time alignment is memorized in **CUSTOM**.

### 1 Touch NEXT on the DSP function menu.

### 2 Touch TIME ALIGNMENT and then touch ADJUSTMENT.

- You cannot select **ADJUSTMENT** when neither **FRONT-L** nor **FRONT-R** is selected in **POSITION**.

### 3 Touch ▲ or ▼ to select the speaker to be adjusted.

Each time you touch ▲ or ▼ selects the speaker in the following order:

**FRONT L** (front speaker left) **CENTER** (center speaker) **FRONT R** (front speaker right)

**REAR R** (rear speaker right) **REAR L** (rear speaker left) **SUB WOOFER** (subwoofer)

- You cannot select speakers whose size is set at **OFF**. (Refer to *Setting the speaker setting* on page 74.)

## Available accessories

### 4 Touch ◀ or ▶ to adjust the distance between the selected speaker and the listening position.

Each time you touch ◀ or ▶ increases or decreases the distance. **0.0inch** to **200.0inch** is displayed as the distance is increased or decreased.

## Using the equalizer

The equalizer lets you adjust the equalization to match the car's interior acoustic characteristics as desired.

### Recalling equalizer curves

There are seven stored equalizer curves which you can easily recall at any time. Here is a list of the equalizer curves.

Display	Equalizer curve
<b>POWERFUL</b>	Powerful
<b>NATURAL</b>	Natural
<b>VOCAL</b>	Vocal
<b>FLAT</b>	Flat
<b>CUSTOM1</b>	Custom 1
<b>CUSTOM2</b>	Custom 2
<b>SUPER BASS</b>	Super bass

- **CUSTOM1** and **CUSTOM2** are adjusted equalizer curves.
- When **FLAT** is selected, no supplement or correction is made to the sound. This is useful to check the effect of the equalizer curves by switching alternatively between **FLAT** and a set equalizer curve.
- Press **EQ** repeatedly to switch between the following equalizers:  
**POWERFUL NATURAL VOCAL FLAT  
CUSTOM1 CUSTOM2 SUPER BASS**

### Adjusting 3-band parametric equalizer

For **CUSTOM1** and **CUSTOM2** equalizer curves, you can adjust the front, rear and center equalizer curves separately by selecting a

center frequency, an equalizer level and a Q factor for each band.

- A separate **CUSTOM1** curve can be created for each source.
- A **CUSTOM2** curve can be created common to all sources.
- The center speaker largely determines the sound image and getting the balance right isn't easy. We recommend reproducing a 2 ch. audio (a CD for example) and getting the balance right among the speakers except for the center, and then reproducing a 5.1 ch. audio (Dolby Digital or DTS) and adjusting the center speaker output to the balance you have already got among the other speakers.

**1 Touch NEXT twice on the DSP function menu.**

**2 Touch PARAMETRIC EQ.**

**3 Touch ▲ or ▼ to select the desired item.**

Each time you touch ▲ or ▼ selects the item in the following order:

**EQ** (equalizer) **SP-SELECT** (speakers)  
**BAND** (bands) **FREQUENCY** (center frequency) **LEVEL** (equalizer level)  
**Q. FACTOR** (Q factor)

**4 Touch ▶ to select the equalizer.**

Touch ▶ repeatedly to switch between the following equalizers:

**POWERFUL NATURAL VOCAL FLAT  
CUSTOM1 CUSTOM2 SUPER BASS**

**5 Touch ▼ and then touch ◀ or ▶ to select the speaker to be adjusted.**

Touch ◀ or ▶ until the desired speaker appears in the display.

**REAR** (rear speakers) **CENTER** (center speaker) **FRONT** (front speakers)

- You cannot select speakers whose size is set at **OFF**. (Refer to *Setting the speaker setting* on page 74.)

**6 Touch ▼ and then touch ◀ or ▶ to select the equalizer band to be adjusted.**

Each time you touch ◀ or ▶ selects equalizer bands in the following order:

## Available accessories

**LOW** (low)   **MID** (mid)   **HIGH** (high)

**7 Touch ▼ and then touch ◀ or ▶ to select the center frequency of selected band.**

Touch ◀ or ▶ until the desired frequency appears in the display.

**40Hz 50Hz 63Hz 80Hz 100Hz 125Hz  
160Hz 200Hz 250Hz 315Hz 400Hz  
500Hz 630Hz 800Hz 1kHz 1.25kHz  
1.6kHz 2kHz 2.5kHz 3.15kHz 4kHz  
5kHz 6.3kHz 8kHz 10kHz 12.5kHz**

**8 Touch ▼ and then touch ◀ or ▶ to adjust the equalizer level.**

Each time you touch ◀ or ▶ it increases or decreases the equalizer level. **+12 to -12** is displayed as the level is increased or decreased.

**9 Touch ▼ and then touch ◀ or ▶ to select the desired Q factor.**

Each time you touch ◀ or ▶ switches between the following Q factor:

**NARROW** (narrow)   **WIDE** (wide)

- You can adjust parameters for each band of the other speakers in the same way.



### Note

You can select a center frequency for each band. You can change the center frequency in 1/3 octave steps, but you cannot select frequencies that have intervals shorter than 1 octave among the center frequencies of the three bands.

## Using the auto-equalizer

The auto equalizer is the equalizer curve created by auto TA and EQ (refer to *Auto TA and EQ (auto time alignment and auto equalizing)* on this page).

You can turn the auto equalizer on or off.

**1 Touch NEXT twice on the DSP function menu.**

**2 Touch AUTO EQ.**

- You cannot use this function if auto TA and EQ has not been carried out.

**3 Touch ▶ to turn the auto-equalizer on.**

- To turn auto equalizer off, touch ◀.

## Auto TA and EQ (auto-time alignment and auto-equalizing)

The auto time alignment is automatically adjusted for the distance between each speaker and the listening position.

The auto equalizer automatically measures the car interior acoustic characteristics, and then creates the auto equalizer curve based on that information.



### WARNING

To prevent accidents, never carry out auto TA and EQ while driving. When this function measures the car interior acoustic characteristics to create an auto equalizer curve, a loud measurement tone (noise) may be outputted from the speakers.



### CAUTION

- Carrying out auto TA and EQ under the following conditions may damage the speakers. Be sure to check the conditions thoroughly before carrying out auto TA and EQ.
  - When speakers are incorrectly connected. (e.g., When a rear speaker is connected to a subwoofer output.)
  - When a speaker is connected to a power amp delivering output higher than the speaker's maximum input power capability.
- If the microphone is placed in an unsuitable position the measurement tone may become loud and measurement may take a long time, resulting in a drain on battery power. Be sure to place the microphone in the specified location.

## Available accessories

### Before operating the auto TA and EQ function

- Carry out auto TA and EQ in as quiet a place as possible, with the car engine and air conditioning switched off. Also cut power to car phones or portable telephones in the car, or remove them from the car before carrying out auto TA and EQ. Sounds other than the measurement tone (surrounding sounds, engine sound, telephones ringing etc.) may prevent correct measurement of the car interior acoustic characteristics.
- Be sure to carry out auto TA and EQ using the supplied microphone. Using another microphone may prevent measurement, or result in incorrect measurement of the car interior acoustic characteristics.
- When front speaker is not connected, auto TA and EQ cannot be carried out.
- When this unit is connected to a power amp with input level control, auto TA and EQ may not be possible if you lower power amp input level. Set the power amp's input level to the standard position.
- When this unit is connected to a power amp with an LPF, turn off the LPF on the power amp before carrying out auto TA and EQ. In addition, the cut off frequency for built in LPF of an active subwoofer should be set to the highest frequency.
- The time alignment value calculated by auto TA and EQ may differ from the actual distance in the following circumstances. However, the distance has been calculated by computer to be the optimum delay to give accurate results for the circumstances, so please continue to use this value.
  - When the reflected sound within a vehicle is strong and delays occur.
  - When delays occur for low sounds due to the influence of the LPF on active subwoofers or external amps.
- Auto TA and EQ changes the audio settings as below:

The fader/balance settings return to the center position. (Refer to page 72.)

The equalizer curve switches to **FLAT**. (Refer to page 77.)

It will be adjusted automatically to high pass filter setting for front, center and rear speaker.

- If you carry out auto TA and EQ when a previous setting of this already exists, the setting will be replaced.

### Carrying out auto TA and EQ

#### 1 Stop the car in a place that is as quiet as possible, close all doors, windows and the sun roof, and then turn the engine off.

If the engine is left running, engine noise may prevent correct auto TA and EQ.

#### 2 Fix the supplied microphone in the center of the headrest of the driver's seat, facing forward, using the belt (sold separately).

The auto TA and EQ may differ depending on where you place the microphone. If desired, place the microphone on the front passenger seat to carry out auto TA and EQ.

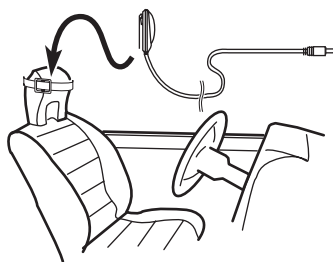

#### 3 Turn the ignition switch to ON or ACC.

If the car's air conditioner or heater is turned on, turn it off. Noise from the fan in the air conditioner or heater may prevent correct auto TA and EQ.

- Press **SRC** to turn the source on if this unit is turned off.

## Available accessories

### 4 Select the position for the seat on which the microphone is placed.

Refer to *Using the position selector* on page 71.

- If no position is selected before you start auto TA and EQ, **FRONT-L** is selected automatically.

### 5 Press SRC and hold until the unit turns off.

### 6 Press and hold EQ to enter the auto TA and EQ measurement mode.

### 7 Plug the microphone into the microphone input jack on the multi-channel processor.

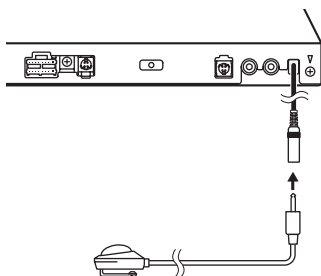

For details concerning operation, refer to the multi channel processor's operation manual.

### 8 Touch START to start the auto TA and EQ.

### 9 Get out of the car and close the door within 10 seconds when the 10-second count-down starts.

The measurement tone (noise) is outputted from the speakers, and auto TA and EQ begins.

- When all speakers are connected, auto TA and EQ is completed in about nine minutes.
- To stop auto TA and EQ, touch **STOP**.
- To cancel auto TA and EQ part way through, touch **BACK** or **ESC**.

### 10 When auto TA and EQ is completed, Complete is displayed.

When correct measurement of car interior acoustic characteristics is not possible, an

error message is displayed. (Refer to *Under standing auto TA and EQ error messages* on page 85.)

### 11 Touch ESC to cancel the auto TA and EQ mode.

### 12 Store the microphone carefully in the glove compartment.

Store the microphone carefully in the glove compartment or any other safe place. If the microphone is subjected to direct sunlight for an extended period, high temperatures may cause distortion, color change or mal function. 



## Additional Information

### Troubleshooting

#### Common

Symptom	Cause	Action (See)
Power doesn't turn on. The unit doesn't operate.	Leads and connectors are incorrectly connected.	Confirm once more that all connections are correct.
	The fuse is blown.	Rectify the reason for the fuse blowing, then replace the fuse. Be very sure to install a fuse with the same rating.
	Noise and other factors are causing the built in microprocessor to operate incorrectly.	Press <b>RESET</b> . (Page 13)
Operation with the remote control isn't possible. The unit does not operate correctly even when the appropriate remote control buttons are pressed.	The remote control operation mode is incorrect.	Switch to the correct remote control mode.
	The remote control code is incorrect.	Make sure the remote control selection switch setting and code type setting are the same.
	Battery power is low.	Load new battery.
	Some operations are prohibited with certain discs.	Check by using another disc.
Playback is not possible.	The disc is dirty.	Clean disc. (Page 86)
	The loaded disc is a type this unit cannot play.	Check what type the disc is.
	Non compatible video system disc is loaded.	Change to a disc compatible to your video system.
No sounds are heard. The volume level will not rise.	Cables are not connected correctly.	Connect the cables correctly.
	The unit is performing still, slow motion or frame by frame playback.	There is no sound during still, slow motion or frame by frame playback.
There is no picture.	The parking brake cord is not connected.	Connect a parking brake cord, and apply the parking brake.
	The parking brake is not applied.	Connect a parking brake cord, and apply the parking brake.
The icon  is displayed, and operation is not possible.	The operation is prohibited for the disc.	This operation is not possible.
	The operation is not compatible with the disc's organization.	This operation is not possible.
The picture stops (pauses) and the unit cannot be operated.	Reading of data has become impossible during playback.	After stopping playback once, start playback once more.
There is no sound. Volume level is low.	The volume level is low.	Adjust the volume level.
	The attenuator is on.	Turn the attenuator off.
There is audio and video skipping.	The unit is not firmly secured.	Secure the unit firmly.
The picture is stretched, the aspect is incorrect.	The aspect setting is incorrect for the display.	Select the appropriate setting for your display. (Page 36)
When the ignition switch is turned ON (or turned to ACC), the motor sounds.	The unit is confirming whether a disc is loaded or not.	This is a normal operation.

## Additional Information

Nothing is displayed. The touch panel keys cannot be used.	The rear view camera is not connected. <b>CAMERA POLARITY</b> is at incorrect setting.	Connect a rear view camera. Press and hold <b>VOLUME/MUTE</b> to return to the source display and then select the correct setting for <b>CAMERA POLARITY</b> . (Page 43)
---	---	---

### Problems during DVD playback

Symptom	Cause	Action (See)
Playback is not possible.	The loaded disc has a different region number from this unit.	Replace the disc with one featuring the same region number as this unit. (Page 9, Page 95)
A parental lock message is displayed and playback is not possible.	Parental lock is on.	Turn parental lock off or change the level. (Page 36)
Parental lock cannot be canceled.	The code number is incorrect.	Input the correct code number. (Page 36)
	You have forgotten your code number.	Touch <b>C</b> 10 times to cancel the code number. (Page 37)
Dialog language (and subtitle language) cannot be switched.	The DVD playing does not feature multiple language recordings.	You cannot switch among multiple languages if they are not recorded on the disc.
	You can only switch between items indicated in the disc menu.	Switch using the disc menu.
No subtitles are displayed.	The DVD playing does not feature subtitles.	Subtitles are not displayed if they are not recorded on the disc.
	You can only switch between items indicated in the disc menu.	Switch using the disc menu.
Playback is not with the audio language and subtitle language settings selected in <b>DVD SETUP</b> .	The DVD playing does not feature dialog or subtitles in the language selected in <b>DVD SETUP</b> .	Switching to a selected language is not possible if the language selected in <b>DVD SETUP</b> is not recorded on the disc.
Switching the viewing angle is not possible.	The DVD playing does not feature scenes shot from multiple angles.	You cannot switch between multiple angles if the DVD does not feature scenes recorded from multiple angles.
	You are trying to switch to multiple angle viewing of a scene that is not recorded from multiple angles.	Switch between multiple angles when watching scenes recorded from multiple angles.
The picture is extremely unclear/distorted and dark during playback.	The disc features a signal to prohibit copying. (Some discs may have this.)	Since this unit is compatible with the copy guard analog copy protect system, when playing a disc that has a signal prohibiting copying, the picture may suffer from horizontal stripes or other imperfections when viewed on some displays. This does not mean this unit is malfunctioning.

### Problems during Video CD playback

Symptom	Cause	Action
The PBC (playback control) menu display cannot be called up.	The Video CD playing does not feature PBC.	This operation is not possible with Video CDs not featuring PBC.
Repeat play and track/time search are not possible.	The Video CD playing features PBC.	This operation is not possible with Video CDs featuring PBC.

## Additional Information

### Problems during iPod playback

Symptom	Cause	Action
iPod doesn't operate correctly.	Cables are incorrectly connected.	Disconnect the cable from iPod. Once iPod main menu is displayed, connect the cable again. Reset the iPod.
	The iPod version is old.	Update the iPod version.

### Problems during multi-channel processor connection

Symptom	Cause	Action (See)
No sounds are heard. The volume level will not rise.	Optical cables are not connected correctly.	Connect the cables correctly.
Even if multi channel audio is selected, 2 channel audio is out put.	Digital output setting is set to <b>Linear PCM</b> .	Normally, set the digital output setting to <b>STREAM</b> . (Page 38)



## Error messages

When you contact your dealer or your nearest Pioneer Service Center, be sure to have the error message recorded.

### Built-in DVD player

Message	Cause	Action
<b>DIFFERENT REGION DISC</b>	The disc does not have the same region number as this unit	Replace the DVD video with one bearing the correct region number.
<b>ERROR-02-XX</b>	Dirty disc	Clean disc.
	Scratched disc	Replace disc.
	The disc is loaded upside down	Check that the disc is loaded correctly.
<b>NON-PLAYABLE DISC</b>	Electrical or mechanical	Press <b>RESET</b> .
	This type of disc cannot be played by this unit	Replace the disc with one this unit can play.
<b>PROTECT</b>	The inserted disc does not contain any files that can be played back	Replace disc.
	All the files on the inserted disc are secured by DRM	Replace disc.
<b>SKIPPED</b>	The inserted disc contains WMA files that are protected by DRM	Replace disc.
<b>TEMP</b>	The temperature of this unit is outside the normal operating range	Wait until the unit's temperature returns to within normal operating limits.

## Additional Information



### USB audio player/USB memory

Message	Cause	Action
<b>NO AUDIO</b>	No songs	Transfer the audio files to the USB portable audio player/USB memory and connect.
	USB memory with security enabled is connected	Follow the USB memory instructions to disable the security.
<b>SKIPPED</b>	The connected USB portable audio player/USB memory contains WMA files that are protected by Windows Media DRM 9/10	Play an audio file not protected by Windows Media DRM 9/10.
<b>PROTECT</b>	All the files on the connected USB portable audio player/USB memory are protected by Windows Media DRM 9/10	Transfer audio files not protected by Windows Media DRM 9/10 to the USB portable audio player/USB memory and connect.
<b>N/A USB</b>	The USB device connected to is not supported by this unit.	Connect a USB portable audio player or USB memory that is USB Mass Storage Class compliant.
<b>CHECK USB</b>	The USB connector or USB cable is short circuited.	Confirm that the USB connector or USB cable is not caught in something or damaged.
	The connected USB portable audio player/USB memory consumes more than 500 mA (maximum allowable current).	Disconnect the USB portable audio player/USB memory and do not use it. Turn the ignition switch to OFF, then to ACC or ON and then connect the compliant USB portable audio player/USB memory.
<b>ERROR-19</b>	Communication failure	Perform one of the following operations. Turn the ignition switch OFF and back ON. Disconnect the USB portable audio player/USB memory. Change to a different source. Then, return to the USB portable audio player/USB memory.
<b>ERROR-23</b>	USB device is not formatted with FAT16 or FAT32	USB device should be formatted with FAT16 or FAT32.

### iPod

Message	Cause	Action
<b>ERROR-11</b>	Communication failure	Disconnect the cable from iPod. Once iPod main menu is displayed, connect the cable again. Reset the iPod.
<b>ERROR-21</b>	Old version of iPod	Update the iPod version.
<b>ERROR-30</b>	iPod failure	Reset the iPod.
<b>No Songs</b>	No songs	Transfer the songs to iPod.
<b>STOP</b>	No songs in the current list	Select a list that contains the songs.

## Additional Information

	iPod is not charged but operates correctly	Check if the connection cable for iPod shorted out (e.g., not caught in metal objects). After checking, turn the ignition switch OFF and back ON or disconnect the iPod and connect again.
	Error has occurred when connecting the iPod to this unit	Reconnect the iPod. Turn the ignition switch to OFF, then to ACC or ON. Update the iPod version.

## Understanding auto TA and EQ error messages

When correct measurement of car interior acoustic characteristics is not possible using the auto TA and EQ, an error message may appear on the display. If an error message appears, refer to the table below to see what the problem is and the suggested method of correcting the problem. After checking, try again.

Message	Cause	Action
<b>Error. Please check MIC.</b>	Microphone is not connected.	Plug the supplied microphone securely into the jack.
<b>Error. Please check front SP.</b> <b>Error. Please check FL SP.</b> <b>Error. Please check FR SP.</b> <b>Error. Please check center SP.</b> <b>Error. Please check rear SP.</b> <b>Error. Please check RL SP.</b> <b>Error. Please check RR SP.</b> <b>Error. Please check subwoofer</b>	The microphone cannot pick up the measuring tone of a speaker.	<ul style="list-style-type: none"> <li>• Confirm that the speakers are connected correctly.</li> <li>• Correct the input level setting of the power amp connected to the speakers.</li> <li>• Set the microphone correctly.</li> </ul>
<b>Error. Please check noise.</b>	The surrounding noise level is too high.	<ul style="list-style-type: none"> <li>• Stop your car in a place that is as quiet as possible, and switch off the engine, air conditioner or heater.</li> <li>• Set the microphone correctly.</li> </ul>

## Additional Information

### Handling guideline of discs and player

- Use only conventional, fully circular discs. Do not use shaped discs.



- Use 12 cm or 8 cm disc. Do not use an adapter when playing 8 cm discs.
- Do not insert anything other than a disc into the disc loading slot. Discs which can be played back are listed on *Playable discs* on page 9.
- Do not use cracked, chipped, warped, or otherwise damaged discs as they may damage the player.
- Do not touch the recorded surface of the discs.
- Store discs in their cases when not in use.
- Avoid leaving discs in excessively hot environments including under direct sunlight.
- Do not attach labels, write on or apply chemicals to the surface of the discs.
- To clean a disc, wipe the disc with a soft cloth outward from the center.
- Condensation may temporarily impair the player's performance. Leave it to adjust to the warmer temperature for about one hour. Also, wipe any dump discs with a soft cloth.
- Playback of discs may not be possible because of disc characteristics, disc format, recorded application, playback environment, storage conditions, and so on.
- Road shocks may interrupt disc playback.
- Read the precautions for discs before using them.

### DVD discs

- With some DVD video discs, it may not be possible to use certain functions.

- It may not be possible to play back some DVD video discs.
- It is not possible to play back DVD ROM/DVD RAM discs.

### DVD-R/DVD-RW discs

- Unfinalized DVD R/ RW discs which have been recorded with the Video format (video mode) cannot be played back.
- DVD R/ RW discs which have been recorded with the Video Recording format (VR mode) cannot be played back.
- For more information about recording mode, please contact manufacture of DVD recorder or application.

### AVCHD recorded discs

- This unit is not compatible with discs recorded in AVCHD (Advanced Video Codec High Definition) format. Do not insert AVCHD discs. If inserted, the disc may not be ejected.

### CD-R/CD-RW discs

- When CD R/CD RW discs are used, playback is possible only for discs which have been finalized.
- It may not be possible to play back CD R/ CD RW discs recorded on a music CD recorder or a personal computer because of disc characteristics, scratches or dirt on the disc, or dirt, condensation, etc., on the lens of this unit.
- Playback of discs recorded on a personal computer may not be possible, depending on the application settings and the environment. Please record with the correct format. (For details, contact the manufacturer of the application.)

## Additional Information

- Playback of CD R/CD RW discs may be come impossible in case of direct exposure to sunlight, high temperatures, or the storage conditions in the vehicle.
- Titles and other text information recorded on a CD R/CD RW disc may not be displayed by this unit (in the case of audio data (CD DA)).
- Read the precautions with CD R/CD RW discs before using them. 

## Dual Discs

- Dual Discs are two sided discs that have a recordable CD for audio on one side and a recordable DVD for video on the other.
- Playback of the DVD side is possible with this unit. However, since the CD side of Dual Discs is not physically compatible with the general CD standard, it may not be possible to play the CD side with this unit.
- Frequent loading and ejecting of a Dual Disc may result in scratches on the disc. Serious scratches can lead to playback problems on this unit. In some cases, a Dual Disc may become stuck in the disc loading slot and will not eject. To prevent this, we recommend you refrain from using Dual Disc with this unit.
- Please refer to the information from the disc manufacturer for more detailed information about Dual Discs. 

## Compressed audio files on the disc

- ISO 9660 Level 1 and 2 compliant. Romeo and Joliet file systems are both compatible with this player.
- Multi session playback is possible.
- Compressed audio files are not compatible with packet write data transfer.
- Only 64 characters from the beginning can be displayed as a file name (including the extension such as .wma or .mp3) or a folder name.
- Folder selection sequence or other operation may be altered depending on the encoding or writing software.
- Regardless of the length of blank section between the songs of original recording, compressed audio discs play with a short pause between songs.
- File extensions such as .wma, .mp3 or .m4a must be used properly.

## Example of a hierarchy

 Folder

 Compressed audio file

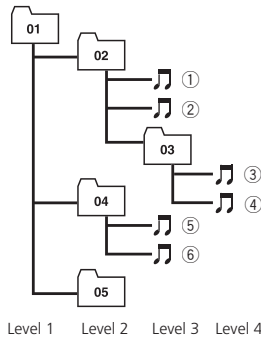

- This unit assigns folder numbers. The user cannot assign folder numbers.
- It is possible to play back up to 255 folders on one disc.

## Additional Information

### Compressed audio compatibility

#### WMA

- Compatible format: WMA encoded by Windows Media Player
- Bit rate: 5 kbps to 320 kbps (CBR), VBR
- Sampling frequency: 8 kHz to 48 kHz
- Windows Media Audio 9 Professional, Lossless, Voice: No

#### MP3

- Bit rate: 8 kbps to 320 kbps (CBR), VBR
- Sampling frequency: 8 kHz to 48 kHz (8 kHz to 48 kHz for emphasis)
- Compatible ID3 tag version: 1.0, 1.1, 2.2, 2.3 (ID3 tag Version 2.x is given priority than Version 1.x.)
- M3u playlist: No
- MP3i (MP3 interactive), mp3 PRO: No

#### AAC

- Compatible format: AAC encoded by iTunes®
- Bit rate: 8 kbps to 320 kbps (CBR)
- VBR: No
- Sampling frequency: 8 kHz to 44.1 kHz
- Apple Lossless: No

### USB audio player/USB memory

#### USB audio player/USB memory compatibility

- USB version: 2.0, 1.1 and 1.0
- USB data transfer rate: full speed
- USB Class: MSC (Mass Storage Class) device
- Protocol: bulk
- Minimum amount of memory: 250 MB
- Maximum amount of memory: 250 GB
- File system: FAT32 and FAT16
- Supply current: 500 mA



#### Notes

- Partitioned USB memory is not compatible with this unit.

- Depending on the kind of USB portable audio player/USB memory you use, this unit may not recognize the USB audio player/USB memory or audio files may not be played back properly.
- This unit can play back files in the USB portable audio player/USB memory that is USB Mass Storage Class. However, copyright protected files that are stored in above mentioned USB devices cannot be played back.
- You cannot connect a USB portable audio player/USB memory to this unit via a USB hub.

### Handling guideline and supplemental information

- Do not leave the USB portable audio player/USB memory in direct sunlight for extended amounts of time. Extended exposure to direct sunlight can result in USB portable audio player/USB memory malfunction due to the resulting high temperature.
- Do not leave the USB portable audio player/USB memory in high temperature.
- Firmly secure the USB portable audio player/USB memory when driving. Do not let the USB portable audio player/USB memory fall onto the floor, where it may be come jammed under the brake or accelerator pedal.
- There may be a slight delay when starting playback of audio files encoded with image data.
- Depending on the USB devices connected to this unit, it may generate noise in the radio.
- Only 22 characters from the beginning can be displayed as a file name (including the extension) or a folder name when USB portable audio player/USB memory is selected as a source.
- The text information of some audio files may not be correctly displayed.
- File extensions must be used properly.



## Additional Information

- Up to 15 000 files on a USB portable audio player/USB memory can be played back.
- Up to 500 folders on a USB portable audio player/USB memory can be played back.
- Up to eight tiers directory on a USB portable audio player/USB memory can be played back.
- There may be a slight delay when starting playback of audio files on a USB portable audio player/USB memory with numerous folder hierarchies.
- Do not connect anything other than the USB portable audio player/USB memory.
- Operations may vary depending on the kind of USB audio player and a USB memory.

### The sequence of audio files on USB memory

For USB portable audio players, the sequence is different from that of USB memory and depends on the player.

### Example of a hierarchy

📁: Folder

🎵: Compressed audio file

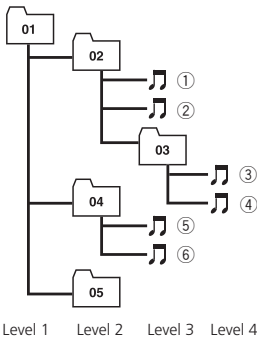

- 01 to 05 represent assigned folder numbers. ① to ⑥ represent the playback sequence. The user cannot assign folder numbers and specify the playback sequence with this unit.

- Playback sequence of the audio file is the same as recorded sequence in the USB device.
- To specify the playback sequence, the following method is recommended.

- 1 Create the file name including numbers that specify the playback sequence (e.g., 001xxx.mp3 and 099yyy.mp3).
- 2 Put those files into a folder.
- 3 Record the folder containing files into the USB device.

However, depending on the system environment, you cannot specify the file playback sequence.

### Compressed audio compatibility

#### WMA

- Compatible format: WMA encoded by Windows Media Player
- Bit rate: 48 kbps to 320 kbps (CBR), 48 kbps to 384 kbps (VBR)
- Sampling frequency: 32 kHz to 48 kHz
- Windows Media Audio 9 Professional, Lossless, Voice: No

#### MP3

- Bit rate: 8 kbps to 320 kbps
- Sampling frequency: 16 kHz to 48 kHz (32, 44.1, 48 kHz for emphasis)
- Compatible ID3 tag version: 1.0, 1.1, 2.2, 2.3, 2.4 (ID3 tag Version 2.x is given priority than Version 1.x.)
- M3u playlist: No
- MP3i (MP3 interactive), mp3 PRO: No

#### AAC

- Compatible format: AAC encoded by iTunes®
- Sampling frequency: 11.025 kHz to 48 kHz
- Transmission rate: 16 kbps to 320 kbps
- Apple Lossless: No

#### WAV

- Compatible format: Linear PCM (LPCM), MS ADPCM

## Additional Information

- Quantization bits: 8 and 16 (LPCM), 4 (MS ADPCM)
- Sampling frequency: 16 kHz to 48 kHz (LPCM), 22.05 kHz to 44.1 kHz (MS ADPCM)

### DivX video files

- Depending on the file information composition such as the number of audio stream, there may be a slight delay in the start of playback on discs.
- Some special operation may be prohibited because of the composition of DivX files.
- DivX files downloaded only from DivX partner site are guarantee of proper operation. Unauthorized DivX file may not operate properly.
- DRM rental file cannot be operated until starting playing back.
- This unit corresponds to a DivX file display up to 1 590 minutes 43 seconds. Also, search operation beyond this time limit is prohibited.
- If a file contains more than 4 GB, playback is stopped on the way.
- DivX VOD file playback requires ID code of this unit to DivX VOD provider. About ID code, refer to *Displaying your DivX® VOD registration code* on page 37.
- File extensions such as .avi or .divx must be used properly.
- For more details about DivX, visit the following site:  
<http://www.divx.com/>

### DivX compatibility

- Compatible format: DivX video format implemented in relation to DivX standards
- DivX Ultra format: No
- DivX files without video data: No
- Compatible audio codec: MP2, MP3, Dolby Digital
- LPCM: No
- Bit rate: 8 kbps to 320 kbps (CBR), VBR

- Sampling frequency: 8 kHz to 48 kHz
- Compatible external subtitle file extension: .srt

### About handling the iPod

#### CAUTION

- Pioneer accepts no responsibility for data lost on the iPod even if that data is lost while using this unit.
- Do not leave the iPod in direct sunlight for extended amounts of time. Extended exposure to direct sunlight can result in iPod malfunction due to the resulting high temperature.
- Do not leave the iPod in a high temperature.
- Firmly secure the iPod when driving. Do not let the iPod fall onto the floor, where it may become jammed under the brake or accelerator pedal.

For details, refer to the iPod's manuals.

### About iPod settings

- You cannot operate the iPod Equalizer on Pioneer products. We recommend that you set the iPod Equalizer to off, before connecting to this unit.
- You cannot set Repeat to off on the iPod when using this unit. Even if you set Repeat to off on the iPod, Repeat is automatically changed to All when connecting the iPod to this unit.

### Using the display correctly

#### CAUTION

- If liquid or foreign matter should get inside this unit, turn off the power immediately and consult your dealer or the nearest authorized PIONEER Service Station. Do not use the unit in this condition because doing so may result in a fire, electric shock, or other failure.

## Additional Information

- If you notice smoke, a strange noise or smell, or any other abnormal signs from the display, turn off the power immediately and consult your dealer or the nearest authorized PIONEER Service Station. Using this unit in this condition may result in permanent damage to the system.
- Do not disassemble or modify this unit, as there are high voltage components inside which may cause an electric shock. Be sure to consult your dealer or the nearest authorized PIONEER Service Station for internal inspection, adjustments or repairs.

### Handling the display

- When the display is subjected to direct sunlight for a long period of time, it will become very hot resulting in possible damage to the LCD screen. When not using this unit, close the display and avoid exposing it to direct sunlight.
- The display should be used within the temperature ranges shown below.  
Storage temperature range: 4 °F to +176 °F  
At temperatures higher or lower than the operating temperature range the display may not operate normally.
- The LCD screen of this unit is exposed in order to increase its visibility within the vehicle. Please do not press strongly on it as this may damage it.
- Do not push the LCD screen with much force as this may scratch it.
- Be careful of fingers, long hair, and loose articles of clothing which could possibly get caught between the display and the main body and cause serious injury.

### Liquid crystal display (LCD) screen

- If the display is near the vent of an air conditioner when it is opened, make sure that air from the air conditioner is not blowing on it. Heat from the heater may damage the LCD screen, and cool air from the cooler may cause moisture to form inside the

display resulting in possible damage. Also, if the display is cooled down by the cooler, the screen may become dark, or the life span of the small fluorescent tube used inside the display may be shortened.

- Small black dots or white dots (bright dots) may appear on the LCD screen. These are due to the characteristics of the LCD screen and do not indicate a problem with the display.
- At low temperatures, the LCD screen may be dark for a while after the power is turned on.
- The LCD screen will be difficult to see if it is exposed to direct sunlight.
- When using a portable phone, keep the antenna of the portable phone away from the display to prevent disruption of the video by the appearance of spots, colored stripes, etc.

### Keeping the display in good condition

- When removing dust from the screen or cleaning the display, first turn the system power off, then wipe with a soft dry cloth.
- When wiping the screen, take care not to scratch the surface. Do not use harsh or abrasive chemical cleaners.

### Small fluorescent tube

- A small fluorescent tube is used inside the display to illuminate the LCD screen.

The fluorescent tube should last for approximately 10 000 hours, depending on operating conditions. (Using the display at low temperatures reduces the service life of the fluorescent tube.)

When the fluorescent tube reaches the end of its useful life, the screen will be dark and the image will no longer be projected. If this happens, consult your dealer or the nearest authorized PIONEER Service Station. ■

# Additional Information

## Language code chart for DVD

Language (code), input code	Language (code), input code	Language (code), input code
Japanese (ja), <b>1001</b>	Guarani (gn), <b>0714</b>	Pashto, Pushto (ps), <b>1619</b>
English (en), <b>0514</b>	Gujarati (gu), <b>0721</b>	Quechua (qu), <b>1721</b>
French (fr), <b>0618</b>	Hausa (ha), <b>0801</b>	Rhaeto Romance (rm), <b>1813</b>
Spanish (es), <b>0519</b>	Hindi (hi), <b>0809</b>	Kirundi (rn), <b>1814</b>
German (de), <b>0405</b>	Croatian (hr), <b>0818</b>	Romanian (ro), <b>1815</b>
Italian (it), <b>0920</b>	Hungarian (hu), <b>0821</b>	Kinyarwanda (rw), <b>1823</b>
Chinese (zh), <b>2608</b>	Armenian (hy), <b>0825</b>	Sanskrit (sa), <b>1901</b>
Dutch (nl), <b>1412</b>	Interlingua (ia), <b>0901</b>	Sindhi (sd), <b>1904</b>
Portuguese (pt), <b>1620</b>	Interlingue (ie), <b>0905</b>	Sangho (sg), <b>1907</b>
Swedish (sv), <b>1922</b>	Inupiak (ik), <b>0911</b>	Serbo Croatian (sh), <b>1908</b>
Russian (ru), <b>1821</b>	Indonesian (in), <b>0914</b>	Sinhalese (si), <b>1909</b>
Korean (ko), <b>1115</b>	Icelandic (is), <b>0919</b>	Slovak (sk), <b>1911</b>
Greek (el), <b>0512</b>	Hebrew (iw), <b>0923</b>	Slovenian (sl), <b>1912</b>
Afar (aa), <b>0101</b>	Yiddish (ji), <b>1009</b>	Samoa (sm), <b>1913</b>
Abkhazian (ab), <b>0102</b>	Javanese (jw), <b>1023</b>	Shona (sn), <b>1914</b>
Afrikaans (af), <b>0106</b>	Georgian (ka), <b>1101</b>	Somali (so), <b>1915</b>
Amharic (am), <b>0113</b>	Kazakh (kk), <b>1111</b>	Albanian (sq), <b>1917</b>
Arabic (ar), <b>0118</b>	Greenlandic (kl), <b>1112</b>	Serbian (sr), <b>1918</b>
Assamese (as), <b>0119</b>	Cambodian (km), <b>1113</b>	Siswati (ss), <b>1919</b>
Aymara (ay), <b>0125</b>	Kannada (kn), <b>1114</b>	Sesotho (st), <b>1920</b>
Azerbaijani (az), <b>0126</b>	Kashmiri (ks), <b>1119</b>	Sundanese (su), <b>1921</b>
Bashkir (ba), <b>0201</b>	Kurdish (ku), <b>1121</b>	Swahili (sw), <b>1923</b>
Byelorussian (be), <b>0205</b>	Kirghiz (ky), <b>1125</b>	Tamil (ta), <b>2001</b>
Bulgarian (bg), <b>0207</b>	Latin (la), <b>1201</b>	Telugu (te), <b>2005</b>
Bihari (bh), <b>0208</b>	Lingala (ln), <b>1214</b>	Tajik (tg), <b>2007</b>
Bislama (bi), <b>0209</b>	Laothian (lo), <b>1215</b>	Thai (th), <b>2008</b>
Bengali (bn), <b>0214</b>	Lithuanian (lt), <b>1220</b>	Tigrinya (ti), <b>2009</b>
Tibetan (bo), <b>0215</b>	Latvian (lv), <b>1222</b>	Turkmen (tk), <b>2011</b>
Breton (br), <b>0218</b>	Malagasy (mg), <b>1307</b>	Tagalog (tl), <b>2012</b>
Catalan (ca), <b>0301</b>	Maori (mi), <b>1309</b>	Setswana (tn), <b>2014</b>
Corsican (co), <b>0315</b>	Macedonian (mk), <b>1311</b>	Tonga (to), <b>2015</b>
Czech (cs), <b>0319</b>	Malayalam (ml), <b>1312</b>	Turkish (tr), <b>2018</b>
Welsh (cy), <b>0325</b>	Mongolian (mn), <b>1314</b>	Tsonga (ts), <b>2019</b>
Danish (da), <b>0401</b>	Moldavian (mo), <b>1315</b>	Tatar (tt), <b>2020</b>
Bhutani (dz), <b>0426</b>	Marathi (mr), <b>1318</b>	Twi (tw), <b>2023</b>
Esperanto (eo), <b>0515</b>	Malay (ms), <b>1319</b>	Ukrainian (uk), <b>2111</b>
Estonian (et), <b>0520</b>	Maltese (mt), <b>1320</b>	Urdu (ur), <b>2118</b>
Basque (eu), <b>0521</b>	Burmese (my), <b>1325</b>	Uzbek (uz), <b>2126</b>
Persian (fa), <b>0601</b>	Nauru (na), <b>1401</b>	Vietnamese (vi), <b>2209</b>
Finnish (fi), <b>0609</b>	Nepali (ne), <b>1405</b>	Volapük (vo), <b>2215</b>
Fiji (fj), <b>0610</b>	Norwegian (no), <b>1415</b>	Wolof (wo), <b>2315</b>
Faroese (fo), <b>0615</b>	Occitan (oc), <b>1503</b>	Xhosa (xh), <b>2408</b>
Frisian (fy), <b>0625</b>	Oromo (om), <b>1513</b>	Yoruba (yo), <b>2515</b>
Irish (ga), <b>0701</b>	Oriya (or), <b>1518</b>	Zulu (zu), <b>2621</b>
Scots Gaelic (gd), <b>0704</b>	Panjabi (pa), <b>1601</b>	
Galician (gl), <b>0712</b>	Polish (pl), <b>1612</b>	



## Additional Information

### Terms

#### AAC

AAC is short for Advanced Audio Coding and refers to an audio compression technology standard used with MPEG 2 and MPEG 4.

#### Aspect ratio

This is the width to height ratio of a TV screen. A regular display has an aspect ratio of 4:3. Wide screen displays have an aspect ratio of 16:9, providing a bigger picture for exceptional presence and atmosphere.

#### Bit rate

This expresses data volume per second, or bps (bits per second) units. The higher the rate, the more information is available to reproduce the sound. Using the same encoding method (such as MP3), the higher the rate, the better the sound.

#### Chapter

DVD titles are in turn divided into chapters which are numbered in the same way as the chapters of a book. With DVD video discs featuring chapters, you can quickly find a desired scene with chapter search.

#### DivX

DivX is a popular media technology created by DivX, Inc. DivX media files contain highly compressed video with high visual quality that maintains a relatively small file size. DivX files can also include advanced media features like menus, subtitles, and alternate audio tracks. Many DivX media files are available for download online, and you can create your own using your personal content and easy to use tools from DivX.com.

#### DivX Certified

DivX Certified products are officially tested by the creators of DivX and guaranteed to play all versions of DivX video, including DivX 6.

#### Dolby Digital

Dolby Digital provides multi channel audio from up to 5.1 independent channels. This is

the same as the Dolby Digital surround sound system used in theaters.

#### Dolby Pro Logic II

Dolby Pro Logic II can create five full band width output channels from two channel sources. This new technology enables a discrete 5 channel playback with 2 front channels, 1 center channel, and 2 rear channels. A music mode is also available for 2 channel sources in addition to the movie mode.

#### DTS

This stands for Digital Theater Systems. DTS is a surround system delivering multi channel audio from up to 6 independent channels.

#### Dynamic range control

Dolby Digital has a function for compressing the difference between the loudest and softest sounds: Dynamic range control. This control ensures sounds with an increased dynamic range are heard clearly even at low volume levels.

#### ID3 tag

This is a method of embedding track related information in an MP3 file. This embedded information can include the track title, the artist's name, the album title, the music genre, the year of production, comments and other data. The contents can be freely edited using software with ID3 Tag editing functions. Although the tags are restricted as to the number of characters, the information can be viewed when the track is played back.

#### ISO9660 format

This is the international standard for the format logic of CD ROM folders and files. For the ISO9660 format, there are regulations for the following two levels.

##### Level 1:

The file name is in 8.3 format (the name consists of up to 8 characters, half byte English capital letters and half byte numerals and the "." sign, with a file extension of three characters).

## Additional Information

### Level 2:

The file name can have up to 31 characters (including the separation mark "." and a file extension). Each folder contains less than 8 hierarchies.

### Extended formats

Joliet:

File names can have up to 64 characters.

Romeo:

File names can have up to 128 characters.

### Linear PCM (LPCM)/Pulse code modulation

This stands for linear pulse code modulation, which is the signal recording system used for music CDs and DVDs. Generally, DVDs are recorded with higher sampling frequency and bit rate than CDs. Therefore, DVDs can provide higher sound quality.

### m3u

Playlists created using the "WINAMP" software have a playlist file extension (.m3u).

### MP3

MP3 is short for MPEG Audio Layer 3. It is an audio compression standard set by a working group (MPEG) of the ISO (International Standards Organization). MP3 is able to compress audio data to about 1/10th the level of a conventional disc.

### MPEG

This stands for Moving Pictures Experts Group, and is an international video image compression standard. Some DVDs feature digital audio compressed and recorded using this system.

### Multi-angle

With regular TV programs, although multiple cameras are used to simultaneously shoot scenes, only images from one camera at a time are transmitted to your TV. Some DVDs feature scenes shot from multiple angles, letting you choose your viewing angle as desired.

### Multi-audio (Multilingual dialog)

Some DVDs feature dialog recorded in multiple languages. Dialog in up to 8 languages can be recorded on a single disc, letting you choose as desired.

### Multi-session

Multi session is a recording method that allows additional data to be recorded later. When recording data on a CD ROM, CD R or CD RW, etc., all data from beginning to end is treated as a single unit or session. Multi session is a method of recording more than 2 sessions on one disc.

### Multi-subtitle

Subtitles in up to 32 languages can be recorded on a single DVD, letting you choose as desired.

### Optical digital output/input

By transmitting and receiving audio signals in a digital signal format, the chance of sonic quality deteriorating in the course of transmission is minimized. An optical digital output/input is designed to transmit and receive digital signals optically.

### Packet write

This is a general term for a method of writing on CD R, etc., at the time required for a file, just as is done with files on floppy or hard discs.

### Parental lock

Some DVD video discs with violent or adult or oriented scenes feature parental lock which prevents children from viewing such scenes. With this kind of disc, if you set the unit's parental lock level, playback of scenes inappropriate for children will be disabled, or these scenes will be skipped.

## Additional Information

### Playback control (PBC)

This is a playback control signal recorded on Video CDs (Version 2.0). Using menu displays provided by Video CDs with PBC lets you enjoy playback of simple interactive software and software with search functions. You can also enjoy viewing high and standard resolution still images.

### Region number

DVD players and DVD discs feature region numbers indicating the area in which they were purchased. Playback of a DVD is not possible unless it features the same region number as the DVD player. This unit's region number is displayed on the bottom of the unit.

### Title

DVD video discs have high data capacity, enabling recording of multiple movies on a single disc. If, for example, one disc contains three separate movies, they are divided into title 1, title 2 and title 3. This lets you enjoy the convenience of title search and other functions.

### VBR

VBR is short for variable bit rate. Generally speaking CBR (constant bit rate) is more widely used. But by flexibly adjusting the bit rate according to the needs of audio compression, it is possible to achieve compression priority sound quality.

### WMA

WMA is short for Windows Media™ Audio and refers to an audio compression technology that is developed by Microsoft Corporation. WMA data can be encoded by using Windows Media Player version 7 or later.

Windows Media and the Windows logo are trademarks or registered trademarks of Microsoft Corporation in the United States and/or other countries. □

# Additional Information

## Specifications

### General

Power source .....	14.4 V DC (10.8 V to 15.1 V allowable)
Grounding system .....	Negative type
Max. current consumption .....	10.0 A
Dimensions (W × H × D): DIN	
Chassis .....	178 mm × 100 mm × 162 mm (7 in. × 3 7/8 in. × 6 3/8 in.)
Nose .....	171 mm × 97 mm × 9 mm (6 3/4 in. × 3 7/8 in. × 3/8 in.)
Weight .....	1.8 kg (4 lbs)

### Display

Screen size/aspect ratio .....	6.1 inch wide/16:9 (effective display area: 136 × 72 mm)
Pixels .....	336 960 (1 440 × 234)
Display method .....	TFT active matrix, transmissive type
Color system .....	NTSC
Durable temperature range (power off) .....	4 °F to +176 °F

### Audio

Maximum power output .....	50 W × 4 50 W × 2/4 Ω + 70 W × 1/2 Ω (for subwoofer)
Continuous power output .....	22 W × 4 (1 kHz, 5% THD, 4 Ω load, both channels driven)
Load impedance .....	4 Ω to 8 Ω × 4 4 Ω to 8 Ω × 2 + 2 Ω × 1
Preout max output level .....	4.0 V
Equalizer (3 Band Parametric Equalizer):	
Low	
Frequency .....	40/80/100/160 Hz
Q Factor .....	0.35/0.59/0.95/1.15 (+6 dB when boosted)
Gain .....	±12 dB
Mid	
Frequency .....	200/500/1k/2k Hz
Q Factor .....	0.35/0.59/0.95/1.15 (+6 dB when boosted)
Gain .....	±12 dB
High	
Frequency .....	3.15k/8k/10k/12.5k Hz
Q Factor .....	0.35/0.59/0.95/1.15 (+6 dB when boosted)
Gain .....	±12 dB

### HPF:

Frequency .....	50/63/80/100/125 Hz
Slope .....	12 dB/oct

### Subwoofer (mono):

Frequency .....	50/63/80/100/125 Hz
Slope .....	18 dB/oct
Gain .....	+6 dB to 24 dB
Phase .....	Normal/Reverse

### Bass boost:

Gain .....	+12 dB to 0 dB
------------	----------------

### DVD Player

System .....	DVD video, Video CD, CD, WMA, MP3, AAC, DivX system
Usable discs .....	DVD video, Video CD, CD, CD R/RW, DVD R/RW
Region number .....	1
Signal format:	
Sampling frequency .....	44.1/48/96 kHz
Number of quantization bits .....	16/20/24; linear
Frequency response .....	5 Hz to 44 000 Hz (with DVD, at sampling frequency 96 kHz)
Signal to noise ratio .....	97 dB (1 kHz) (IEC A net work) (CD: 96 dB (1 kHz) (IEC A network)) (RCA level)
Output level:	
Video .....	1.0 Vp p/75 Ω (±0.2 V)
Number of channels .....	2 (stereo)
MP3 decoding format .....	MPEG 1 & 2 Audio Layer 3
WMA decoding format .....	Ver. 7, 7.1, 8, 9, 10 (2ch audio) (Windows Media Player)
AAC decoding format .....	MPEG 4 AAC (iTunes® encoded only) (.m4a)
DivX decoding format .....	Home Theater Ver. 3, 4, 5.2 (avi, .divx)

### USB

Specification .....	USB 2.0 full speed
Supply current .....	500 mA
Maximum amount of memory .....	250 GB
File system .....	FAT16, FAT32
MP3 decoding format .....	MPEG 1 & 2 Audio Layer 3
WMA decoding format .....	Ver. 7, 7.1, 8, 9, 10, 11 (2ch audio) (Windows Media Player)
AAC decoding format .....	MPEG 4 AAC (iTunes® encoded only) (.m4a) (Ver. 7.2 and earlier)



## Additional Information

WAV signal format ..... Linear PCM & MS ADPCM  
(Non compressed)

### FM tuner

Frequency range ..... 87.9 MHz to 107.9 MHz  
Usable sensitivity ..... 8 dBf (0.7  $\mu$ V/75  $\Omega$  mono,  
S/N: 30 dB)  
Signal to noise ratio ..... 75 dB (IEC A network)

### AM tuner

Frequency range ..... 530 kHz to 1710 kHz (10  
kHz)  
Usable sensitivity ..... 18  $\mu$ V (S/N: 20 dB)  
Signal to noise ratio ..... 65 dB (IEC A network)

### CEA2006 Specifications



Power output ..... 14 W RMS  $\times$  4 Channels (4  
 $\Omega$  and  $\leq$  1 % THD+N)  
S/N ratio ..... 91 dBA (reference: 1 W into  
4  $\Omega$ )



#### Note

Specifications and the design are subject to modifications without notice due to improvements.

## A

Angle icon .....	24, 36
Aspect ratio .....	36, 93
Audio language .....	23, 35

## B

Bookmark .....	22
Brightness .....	41

## C

Chapter .....	93
Code number .....	36
Color .....	41
Contrast .....	41

## D

DivX .....	93
DivX Certified .....	93
Dolby Digital .....	10, 93
Dolby Pro Logic II .....	93
DTS .....	10, 93
Dynamic range control .....	93

## H

Hue .....	41
-----------	----

## L

Language code chart .....	92
Linear PCM (LPCM) .....	94

## M

Menu language .....	36
MPEG .....	94
Multi angle .....	24, 94
Multi audio .....	23, 94
Multi subtitle .....	23, 94

## O

Optical digital output/input .....	94
------------------------------------	----

## P

Parental lock .....	36, 94
PBC (playback control) .....	20
Playback control (PBC) .....	95

## R

Region number .....	9, 95
---------------------	-------

## S

Subtitle language .....	23, 35
-------------------------	--------

## T

Title .....	95
TV aspect .....	36

## V

Video CD .....	9
----------------	---

## W

Wide screen mode .....	41
------------------------	----

*Register your product at  
Enregistrez votre produit au*

**<http://www.pioneerelectronics.com>**

*See "Visit our website" page  
Voir la page "Visitez notre site Web"*

**PIONEER CORPORATION**

4-1, MEGURO 1-CHOME, MEGURO-KU  
TOKYO 153-8654, JAPAN

**PIONEER ELECTRONICS (USA) INC.**

P.O. Box 1540, Long Beach, California 90801-1540, U.S.A.  
TEL: (800) 421-1404

**PIONEER EUROPE NV**

Haven 1087, Keetberglaan 1, B-9120 Melsele, Belgium  
TEL: (0) 3/570.05.11

**PIONEER ELECTRONICS ASIACENTRE PTE. LTD.**

253 Alexandra Road, #04-01, Singapore 159936  
TEL: 65-6472-7555

**PIONEER ELECTRONICS AUSTRALIA PTY. LTD.**

178-184 Boundary Road, Braeside, Victoria 3195, Australia  
TEL: (03) 9586-6300

**PIONEER ELECTRONICS OF CANADA, INC.**

300 Allstate Parkway, Markham, Ontario L3R 0P2, Canada  
TEL: 1-877-283-5901  
TEL: 905-479-4411

**PIONEER ELECTRONICS DE MEXICO, S.A. de C.V.**

Bldv.Manuel Avila Camacho 138 10 piso  
Col.Lomas de Chapultepec, Mexico, D.F. 11000  
TEL: 55-9178-4270

**先鋒股份有限公司**

總公司：台北市中山北路二段44號13樓  
電話：(02) 2521-3588

**先鋒電子（香港）有限公司**

香港九龍尖沙咀海港城世界商業中心  
9樓901-6室  
電話：(0852) 2848-6488

Published by Pioneer Corporation.  
Copyright © 2007 by Pioneer Corporation.  
All rights reserved.

Printed in Thailand

<CRB2528-A/N> UC

<KSNZX> <07K00000>